



U.S. Department of Transportation
Federal Highway
Administration

Alaska Traffic Manual

Consisting of:

1. Manual on Uniform Traffic Control Devices, 2009 (separate document)
2. Alaska Traffic Manual Supplement, 1/13/12

(This page left intentionally blank.)

Introduction

Alaska Traffic Manual

Support:

01 The Alaska Traffic Manual (ATM) is intended to enhance road safety and operation by specifying uniform, understandable, and effective traffic control devices for Alaska roads.

Standard:

02 **Traffic control devices installed on state roads shall conform to the ATM. Traffic control devices on roads under municipal jurisdiction shall conform, “as far as practicable,” to the ATM, as specified in Alaska Statutes (AS) 28.01.010(d).**

Support:

03 The ATM is comprised of the “*2011 Alaska Traffic Manual Supplement (ATMS)*”; the 2009 edition of the “*Manual on Uniform Traffic Control Devices (MUTCD)*”, published by the Federal Highway Administration; and any adopted revisions or interim addenda to either document issued subsequently.

Standard:

04 **Devices installed or replaced after the publication date of the ATM shall conform to the ATM upon installation. Unless noted otherwise, existing devices that do not conform to the current ATM shall be replaced at the end of their useful life.**

Standard:

05 **Both the ATMS and the MUTCD shall be consulted when researching traffic control device issues.**

Support:

06 How to Use the Alaska Traffic Manual Supplement:

07 The ATMS parts, chapters and sections correlate to the MUTCD parts, chapters and sections in sequence, heading and numbering.

08 The two documents interact as follows:

- MUTCD sections, figures or tables not mentioned in the ATMS are adopted for Alaska without any changes or additions.
- MUTCD text modified by the ATMS is indicated by ~~struckthrough~~ text for deletions and a vertical bar to the right of added text. In some cases, portions of unmodified MUTCD text are shown along with deletions and additions to provide context.
- MUTCD figures and tables modified by the ATMS are changed either as directed by the instructions in brackets ([]) or as shown in the ATMS to replace the MUTCD version.
- Where no equivalent section, figure, or table exists in the MUTCD, the section, figure, or table in the ATMS is the standard. Alaska-unique sections begin with a .100 suffix (as in Section 2C.100). Similarly, Alaska-unique figures and tables begin with -100 suffixes (as in Figure 2C100).

09 Obtaining the MUTCD:

10 The MUTCD and revisions may be obtained from the following publishing agencies:

- American Traffic Safety Services Association (ATSSA): <http://www.atssa.com/OnlineStore.aspx>
- Institute of Transportation Engineers (ITE): www.ite.org/bookstore
- American Association of State Highway and Transportation Officials (AASHTO): https://bookstore.transportation.org/item_details.aspx?ID=1550

11 It may also be downloaded on the Web at http://mutcd.fhwa.dot.gov/pdfs/2009/pdf_index.htm.

12 Other Related Documents:

13 The following Department of Transportation & Public Facilities (DOT&PF) documents can be a useful reference when working on traffic control device design:

- Design details for signs and markers are not included in the ATMS. They are found in the “*Alaska Sign Design Specifications*”.
- The Alaska Department of Transportation and Public Facilities (DOT&PF) “*Alaska Preconstruction Manual*” contains additional information on highway construction, street lighting, and supports for signs, streetlights, and traffic. It pertains only to DOT&PF construction projects.

- The DOT&PF “*Standard Specifications for Highway Construction*” contains descriptions, material requirements, and construction methods for traffic control devices and other items. It pertains only to DOT&PF construction projects.

14 Obtaining the Supplement and Other DOT&PF Documents:

15 You can download the ATM and the above referenced documents for free at the DOT&PF Design and Construction Standards Web site at: <http://www.dot.state.ak.us/stwddes/dcspubs/manuals.shtml>.

16 The web site also provides information on the latest updates to the ATM.



**Alaska
Department of
Transportation
and
Public Facilities**

**Alaska
Traffic Manual
Supplement**

Effective 1/13/12

Supplementing the 2009 Edition of the MUTCD

(This page left intentionally blank.)

Table of Contents

Alaska Traffic Manual Supplement

Part 1 | General

CHAPTER 1A. GENERAL	1
Section 1A.07 Responsibility for Traffic Control Devices.....	1
Section 1A.08 Authority for Placement of Traffic Control Devices.....	2
Section 1A.09 Engineering Study and Engineering Judgment.....	2
Section 1A.10 Interpretations, Experimentations, Changes, and Interim Approvals.....	2
Section 1A.11 Relation to Other Publications.....	3
Section 1A.12 Color Code.....	3
Section 1A.13 Definitions of Headings, Words, and Phrases in this Manual.....	4

Part 2 | Signs

CHAPTER 2A. GENERAL	7
Section 2A.06 Design of Signs.....	7
Section 2A.10 Sign Colors.....	7
Section 2A.12 Symbols.....	7
Section 2A.16 Standardization of Location.....	8
Section 2A.18 Mounting Height.....	9
Section 2A.20 Orientation.....	9
Section 2A.100 Directional and Service Signing.....	10
CHAPTER 2B. REGULATORY SIGNS, BARRICADES, AND GATES	12
Section 2B.03 Size of Regulatory Signs.....	12
Section 2B.12 In-Street and Overhead Pedestrian Crossing Signs (R1-6, R1-6a, R1-9, and R1-9a).....	12
Section 2B.13 Speed Limit Sign (R2-1).....	14
Section 2B.15 Night Speed Limit Plaque (R2-3P).....	15
Section 2B.17 Higher Fines Signs and Plaque (R2-6P, R2-10, and R2-11).....	15
Section 2B.30 KEEP RIGHT EXCEPT TO PASS Sign (R4-16) and SLOWER TRAFFIC KEEP RIGHT Sign (R4-3).....	17
Section 2B.31 TRUCKS USE RIGHT LANE Sign (R4-5).....	18
Section 2B.35 Slow Vehicle Turn-Out Signs (R4-12, R4-13, and R4-14, I-120, and I-122).....	20
Section 2B.39 Selective Exclusion Signs.....	20
Section 2B.47 Design of Parking, Standing, and Stopping Signs.....	22

Section 2B.48 Placement of Parking, Stopping, and Standing Signs	23
Section 2B.52 Traffic Signal Pedestrian and Bicycle Actuation Signs (R10-1 through R10-4, and R10-24 through R10-26)	24
Section 2B.53 Traffic Signal Signs (R10-5 through R10-30)	25
Section 2B.54 No Turn on Red Signs (R10-11 Series, R10-17a, and R10-30)	26
Section 2B.59 Weight Limit Signs (R12-1 through R12-5)	26
Section 2B.60 Weigh Station Signs (R13 Series)	27
Section 2B.64 Headlight Use Signs (R16-5 through R16-11)	27
Section 2B.66 Seat Belt Symbol	28
Section 2B.100 STUDDERED TIRES PROHIBITED Sign (R5-100)	28
Section 2B.101 NO STUDDERED TIRES MAY 1 TO SEPT 15 (APRIL 15 TO SEPT 30) Sign (R12-103)	28
Section 2B.102 NO ROAD MAINTENANCE AFTER (date) Sign (R11-100)	28
Section 2B.103 \$1000 FINE FOR LITTERING Sign (R16-106)	29
Section 2B.104 No Shooting Signs (R16-104, R16-105)	29
Section 2B.105 Chains Required Signs (R12-104 through R12-107)	29
Section 2B.106 ALL VEHICLES STOP AT CUSTOMS Sign (R13-103)	29
CHAPTER 2C. WARNING SIGNS AND OBJECT MARKERS	30
Section 2C.01 Function of Warning Signs	30
Section 2C.03 Design of Warning Signs	30
Section 2C.04 Size of Warning Signs	30
Section 2C.06 Horizontal Alignment Warning Signs	31
Section 2C.08 Advisory Speed Plaque (W13-1P)	32
Section 2C.19 ROAD NARROWS Sign (W5-1)	34
Section 2C.27 Low Clearance Signs (W12-2 and W12-2a)	34
Section 2C.31 Shoulder Signs (W8-4, W8-9, W8-17, W8-23, and W8-25)	35
Section 2C.32 Surface Condition Signs (W8-5, W8-7, W8-8, W8-11, W8-13, and W8-14)	35
Section 2C.36 Advance Traffic Control Signs (W3-1, W3-2, W3-3, W3-4)	36
Section 2C.40 Merge Signs (W4-1, W4-5)	37
Section 2C.41 Added Lane Signs (W4-3, W4-6)	37
Section 2C.46 Intersection Warning Signs (W2-1 through W2-8)	38
Section 2C.48 Traffic Signal Signs (W25-1, W25-2)	38
Section 2C.49 Vehicular Traffic Warning Signs (W8-6, W11-1, W11-5, W11-5a, W11-8, W11-10, W11-11, W11-12P, W11-14, W11-15, and W11-15a)	38
Section 2C.50 Non-Vehicular Warning Signs (W11-2, W11-3, W11-4, W11-6, W11-7, W11-9, and W11-16 through W11-22)	40
Section 2C.51 Playground Sign (W15-1)	40
Section 2C.55 Distance Plaques (W16-2 Series, W16-3 Series, W16-4P, W7-3aP)	41
Section 2C.64 Object Markers for Obstructions Within the Roadway	41

Section 2C.65 Object Markers for Obstructions Adjacent to the Roadway	41
Section 2C.100 One Lane Opposing Two Lane Sign (W6-100).....	42
Section 2C.101 LOAD LIMIT WARNING Sign (W12-101).....	42
Section 2C.102 End Signs (W14-100, W14-101, and W14-102).....	43
Section 2C.103 Slide Area Signs (W16-100 and W16-101).....	43
Section 2C.104 WATCH FOR ICE Sign (W16-102).....	43
Section 2C.105 WATER OVER ROADWAY Sign (W16-103).....	43
Section 2C.106 Avalanche Area Signs (W16-110 through W16-112).....	44
Section 2C.107 WIND AREA Sign (W16-104).....	44
Section 2C.108 ROCKS (W16-105) and Rocks Symbol (W16-116) Signs	44
Section 2C.109 END FREEWAY ½ MILE Sign (W16-107)	44
Section 2C.110 ROAD CLOSED AHEAD (W14-103) and BRIDGE CLOSED AHEAD (W14-104) Signs	44
Section 2C.111 LOW FLYING AIRCRAFT Sign (W16-114)	45
Section 2C.112 AIRCRAFT CROSSING Sign (W16-106).....	45
Section 2C.113 JET BLAST AREA Signs (W16-108 and W16-109)	45
Section 2C.114 SLOW MOVING VEHICLES Sign (W7-100).....	45
Section 2C.115 TRAVEL BEYOND THIS POINT NOT RECOMMENDED . . . Sign (W14-105)	45
Section 2C.116 HIDDEN DRIVEWAY Sign (W7-102).....	45
Section 2C.117 THRU TRAFFIC MERGE LEFT (RIGHT) Sign (W4-100)	46
Section 2C.118 DOG TEAM CROSSING Sign (W11-108)	46
CHAPTER 2D. GUIDE SIGNS—CONVENTIONAL ROADS.....	47
Section 2D.06 Size of Lettering.....	47
Section 2D.09 Numbered Highway Systems.....	47
Section 2D.11 Design of Route Signs.....	49
Section 2D.36 Destination and Distance Signs.....	50
Section 2D.37 Destination Signs (D1 Series).....	51
Section 2D.42 Location of Distance Signs	53
Section 2D.43 Street Name Signs (D3-1 or D3-1a).....	53
Section 2D.44 Advance Street Name Signs (D3-2).....	55
Section 2D.47 Parking Area Guide Sign (D4-1).....	56
Section 2D.55 National Scenic Byways Signs (D6-4, D6-4a).....	56
Section 2D.100 Community Service Sign (D9-204)	57
CHAPTER 2E. GUIDE SIGNS—FREEWAYS AND EXPRESSWAYS.....	59
Section 2E.13 Designation of Destinations	59
CHAPTER 2H. GENERAL INFORMATION SIGNS.....	60
Section 2H.02 General Information Signs (I Series)	60

Section 2H.05 Reference Location Signs (D10-1 through D10-3) and Intermediate Reference Location Signs (D10-1a through D10-3a)	61
Section 2H.06 Enhanced Reference Location Signs (D10-4, D10-5)	63
Section 2H.08 Acknowledgment Signs.....	63
CHAPTER 2I. GENERAL SERVICE SIGNS.....	64
Section 2I.02 General Service Signs for Conventional Roads	64
Section 2I.03 General Service Signs for Freeways and Expressways	68
Section 2I.04 Interstate Oasis Signing.....	70
Section 2I.05 Rest Area and Other Roadside Area Signs	70
Section 2I.08 Tourist Information and Welcome Center Signs.....	71
CHAPTER 2J. SPECIFIC SERVICE SIGNS.....	73
Section 2J.01 Eligibility.....	73
Section 2J.02 Application	74
Section 2J.03 Logos and Logo Sign Panels.....	75
Section 2J.11 Signing Policy	75
CHAPTER 2K. TOURIST-ORIENTED DIRECTIONAL SIGNS	76
Section 2K.06 Sign Locations.....	76
Section 2K.07 State Policy	76
CHAPTER 2M. RECREATIONAL AND CULTURAL INTEREST AREA SIGNS	78
Section 2M.02 Application of Recreational and Cultural Interest Area Signs	78
Section 2M.04 General Design Requirements for Recreational and Cultural Interest Area Symbol Guide Signs	78
CHAPTER 2N. EMERGENCY MANAGEMENT SIGNING.....	80
Section 2N.03 Evacuation Route Signs (EM-1 and EM-1a).....	80
CHAPTER 2S. SPECIAL SIGNS	81
Section 2S.01 Highway Fatality Memorial Signs (I-160 through I-164, and I-167).....	81
Section 2S.02 State Maintenance Begins/Ends Signs (I-180 and I-181).....	81
Section 2S.03 Wildlife Viewing Sign (RS-076).....	81
Section 2S.04 Speedometer Check Station Signs (I-140, I-141B, I-141E and I-142).....	82
Section 2S.05 Customs Station Signing (D8-102, D8-103, D8-104, and R13-103)	82
Section 2S.06 FIRE HYDRANT Sign (M12-1)	82
Section 2S.07 Community Sober Driving Sign Assemblies (I-160, I-165, I-166).....	82
Section 2S.08 Pedestrian Wayfinding Signs	83
Section 2S.09 Game Management Unit/Subsistence Hunt Area signs	83
Section 2S.10 School Destination Signs	84

Part 3 | Markings

CHAPTER 3B. PAVEMENT AND CURB MARKINGS	87
Section 3B.02 No-Passing Zone Pavement Markings and Warrants	87
Section 3B.03 Other Yellow Longitudinal Pavement Markings.....	88
Section 3B.18 Crosswalk Markings.....	88
Section 3B.20 Pavement Word, Symbol, and Arrow Markings.....	90
Section 3B.100 Markings for Climbing and Passing Lanes	90
CHAPTER 3F. DELINEATORS.....	91
Section 3F.03 Delineator Application	91

Part 4 | Highway Traffic Signals

CHAPTER 4D. TRAFFIC CONTROL SIGNAL FEATURES	95
Section 4D.02 Responsibility for Operation and Maintenance	95
Section 4D.04 Meaning of Vehicular Signal Indications.....	95
Section 4D.05 Application of Steady Signal Indications.....	96
Section 4D.11 Number of Signal Faces on an Approach.....	97
Section 4D.15 Mounting Height of Signal Faces	101
Section 4D.17 Signal Indications for Left-Turn Movements – General.....	101
Section 4D.18 Signal Indications for Permissive Only Mode Left-Turn Movements.....	102
Section 4D.19 Signal Indications for Protected Only Mode Left-Turn Movements	103
Section 4D.20 Signal Indications for Protected/Permissive Mode Left-Turn Movements	104
Section 4D.22 Signal Indications for Permissive Only Mode Right-Turn Movements	105
Section 4D.23 Signal Indications for Protected Only Mode Right-Turn Movements.....	105
Section 4D.24 Signal Indications for Protected/Permissive Mode Right-Turn Movements	106
Section 4D.25 Signal Indications for Approaches With Shared Left-Turn/Right-Turn Lanes and No Through Movement	107
CHAPTER 4E. PEDESTRIAN CONTROL FEATURES	108
Section 4E.02 Meaning of Pedestrian Signal Head Indications	108
CHAPTER 4F. PEDESTRIAN HYBRID BEACONS	109
Section 4F.02 Design of Pedestrian Hybrid Beacons	109
CHAPTER 4L. FLASHING BEACONS.....	110
Section 4L.01 General Design and Operation of Flashing Beacons.....	110
Section 4L.02 Intersection Control Beacon	110

Section 4L.03 Warning Beacon	110
CHAPTER 4Z. ACTIVE ADVANCE WARNING FLASHERS.....	111
Section 4Z.01 Application of Active Advance Warning Flashers.....	111
Section 4Z.02 Design of Active Advance Warning Flashers	111

Part 5 | Traffic Control Devices for Low-Volume Roads

CHAPTER 5A. GENERAL.....	113
Section 5A.04 Placement.....	113
CHAPTER 5C. WARNING SIGNS.....	114
Section 5C.10 Advisory Speed Plaque (W13-1P).....	114
Section 5C.12 NO TRAFFIC SIGNS Sign (W18-1).....	114
Section 5C.100 PRIMITIVE ROAD NO WARNING SIGNS Sign (W16-113)	114
CHAPTER 5E. MARKINGS	115
Section 5E.03 Edge Line Markings	115
CHAPTER 5F. TRAFFIC CONTROL FOR HIGHWAY-RAIL GRADE CROSSINGS. 116	
Section 5F.02 Grade Crossing (Crossbuck) Sign and Number of Tracks Plaque (R15-1, R15-2P).....	116

Part 6 | Temporary Traffic Control

CHAPTER 6A. GENERAL.....	117
Section 6A.01 General.....	117
CHAPTER 6B. FUNDAMENTAL PRINCIPLES.....	118
Section 6B.01 Fundamental Principles of Temporary Traffic Control	118
CHAPTER 6C. TEMPORARY TRAFFIC CONTROL ELEMENTS.....	119
Section 6C.01 Temporary Traffic Control Plans	119
CHAPTER 6E. FLAGGER CONTROL	121
Section 6E.03 Hand-Signaling Devices.....	121
CHAPTER 6F. TEMPORARY TRAFFIC CONTROL ZONE DEVICES.....	122
Section 6F.03 Sign Placement.....	122

Section 6F.12 Work Zone and Higher Fines Signs and Plaques	123
Section 6F.12 Double Fine in Work Zone Signs (R16-100, R16-101, R16-102, R2-100, W20-102)	124
Section 6F.16 Warning Sign Function, Design, and Application.....	125
Section 6F.30 NEW TRAFFIC PATTERN AHEAD Sign (W23-2)	126
Section 6F.30 NEW TRAFFIC PATTERN (W3-100)	126
Section 6F.31 Flagger Signs (W20-7, W20-7a).....	126
Section 6F.45 UNEVEN LANES Sign (W8-11)	126
Section 6F.52 Advisory Speed Plaque (W13-1P)	126
Section 6F.56 ROAD WORK NEXT XX MILES Sign (G20-1).....	127

Part 7 | Traffic Control for School Areas

CHAPTER 7A. GENERAL.....	129
Section 7A.02 School Routes and Established School Crossings	129
Section 7A.04 Scope.....	129
Section 7A.100 Rural School Area Traffic Control Summary.....	130
Section 7A.101 Urban School Area Traffic Control Summary.....	130
CHAPTER 7B. SIGNS	133
Section 7B.08 School Sign (S1-1) and Plaques	133
Section 7B.09 School Zone Sign (S1-1) and Plaques (S4-3P, S4-7P) and END SCHOOL ZONE Sign (S5-2)...	133
Section 7B.10 Higher Fines Zone Signs (R2-10, R2-11) and Plaques	134
Section 7B.11 School Advance Crossing Assembly.....	134
Section 7B.12 School Crossing Assembly.....	134
Section 7B.13 School Bus Stop Ahead Sign (S3-1)	134
Section 7B.15 School Speed Limit Assembly (S4-1P, S4-2P, S4-3P, S4-4P, S4-6P, S5-1) and END SCHOOL SPEED LIMIT Sign (S5-3).....	135
Section 7B.16 Reduced School Speed Limit Ahead Sign (S4-5, S4-5a).....	137
Section 7B.100 DRUG FREE SCHOOL ZONE Sign (S6-100).....	137
CHAPTER 7C. MARKINGS.....	138
Section 7C.02 Crosswalk Markings.....	138
CHAPTER 7D. CROSSING SUPERVISION.....	139
Section 7D.01 Types of Crossing Supervision.....	139

Part 8 | Traffic Control for Railroad and Light Rail Transit Grade Crossings

CHAPTER 8A. GENERAL 141
Section 8A.02 Use of Standard Devices, Systems, and Practices at Highway-Rail Grade Crossings 141

CHAPTER 8B. SIGNS AND MARKINGS 143
Section 8B.03 Grade Crossing (Crossbuck) Sign (R15-1) and Number of Tracks Plaque (R15-2P) at Active and Passive Grade Crossings 143
Section 8B.04 Crossbuck Assemblies with YIELD or STOP Signs at Passive Grade Crossings..... 143
Section 8B.06 Grade Crossing Advance Warning Signs (W10 Series) 144
Section 8B.09 DO NOT STOP ON TRACKS Sign (R8-8)..... 144
Section 8B.27 Pavement Markings..... 144
Section 8B.100 BICYCLES (skewed track crossing symbol) USE CAUTION (W10-100) 145

CHAPTER 8C. FLASHING-LIGHT SIGNALS, GATES, AND TRAFFIC CONTROL SIGNALS..... 146
Section 8C.02 Flashing-Light Signals 146

Part 9 | Traffic Control for Bicycle Facilities

CHAPTER 9B. SIGNS 149
Section 9B.18 Bicycle Warning and Combined Bicycle/Pedestrian Signs (W11-1 and W11-15) 149

PART 1

GENERAL

CHAPTER 1A. GENERAL

Section 1A.07 Responsibility for Traffic Control Devices

Standard:

- 01** The responsibility for the design, placement, operation, maintenance, and uniformity of traffic control devices shall rest with the public agency or the official having jurisdiction, or, in the case of private roads open to public travel, with the private owner or private official having jurisdiction. 23 CFR 655.603 adopts the MUTCD as the national standard for all traffic control devices installed on any street, highway, bikeway, or private road open to public travel (see definition in Section 1A.13). When a State or other Federal agency manual or supplement is required, that manual or supplement shall be in substantial conformance with the National MUTCD.
- 02** 23 CFR 655.603 also states that traffic control devices on all streets, highways, bikeways, and private roads open to public travel in each State shall be in substantial conformance with standards issued or endorsed by the Federal Highway Administrator.

State Highways

- 02A** Responsibility for traffic control devices on state highways in Alaska shall rest with the state and all its political subdivisions that have jurisdiction over highways. AS 19.10.040 and AS 19.10.050 state:
- 02B** “The department (DOT&PF) shall classify, designate, and mark highways under its jurisdiction and shall provide a uniform system of marking and posting these highways. The system of marking and posting shall correlate with and shall, as far as possible, conform to the recommendations of the Manual on Uniform Traffic Control Devices as adopted by the American Association of State Highway (and Transportation) Officials.
- 02C** DOT&PF shall prescribe types of traffic control signals to regulate traffic on highways. These signals must correlate with and, as far as possible, conform to the recommendations of the Manual on Uniform Traffic Control Devices as adopted by the American Association of State Highway (and Transportation) Officials. The department shall adopt uniform regulations for the placing and installation of traffic control signals.”
- 02D** The required uniform system of marking and posting is defined in the ATM.
- 02E** DOT&PF determines the need for all traffic control devices on state-maintained roads, prepares designs, maintains records, and supervises their installation. These activities may be done by contract with others or by state forces. Traffic control devices that are not in conformance with this standard or that require specific approval for their installation shall not be installed without the approval of the state traffic and safety engineer.
- 02F** As additional specific powers, DOT&PF “may conduct investigations with the assistance of Department of Public Safety and shall determine safe speed limits and safe speed zones on highways and other roadways under its jurisdiction” (AS 19.10.070) and may designate through highways by erecting stop signs on side road approaches (AS 19.10.080). DOT&PF is authorized to make policy for installing, maintaining, and performing all related functions pertaining to traffic control devices on state highways.

Other Highways

- 02G** AS 28.01.010, the Alaska Uniform Traffic Laws Act, states, in part, that a municipality shall “erect necessary official traffic control devices on streets and highways within its jurisdiction that as far as practicable conform to the current edition of the Alaska Traffic Manual prepared by the Department of Transportation and Public Facilities.”

Section 1A.08 Authority for Placement of Traffic Control Devices

Standard:

- 01 Traffic control devices, advertisements, announcements, and other signs or messages within the highway right-of-way shall be placed only as authorized by a public authority or the official having jurisdiction, or, in the case of private roads open to public travel, by the private owner or private official having jurisdiction, for the purpose of regulating, warning, or guiding traffic.
- 02 When the public agency or the official having jurisdiction over a street or highway or, in the case of private roads open to public travel, the private owner or private official having jurisdiction, has granted proper authority, others such as contractors and public utility companies shall be permitted to install temporary traffic control devices in temporary traffic control zones. Such traffic control devices shall conform with the Standards of this Manual.
- 03 All regulatory traffic control devices shall be supported by laws, ordinances, or regulations.
- 03A The DOT&PF shall be responsible for erecting and maintaining traffic control devices on state-maintained roads. Municipalities and other entities with highway authority shall be responsible for erecting and maintaining traffic control devices on their roads.

Section 1A.09 Engineering Study and Engineering Judgment

Support:

- 01 Definitions of an engineering study and engineering judgment are contained in Section 1A.13.

Standard:

- 02 **This Manual describes the application of traffic control devices, but shall not be a legal requirement for their installation.**

Guidance:

- 02A *The decision to use a particular device at a particular location should be made on the basis of either an engineering study or the application of engineering judgment. Thus, while this Manual provides Standards, Guidance, and Options for design and application of traffic control devices, this Manual should not be considered a substitute for engineering judgment.*

Section 1A.10 Interpretations, Experimentations, Changes, and Interim Approvals

Standard:

- 01 **Design, application, and placement of traffic control devices other than those adopted in this Manual shall be prohibited unless the provisions of this Section are followed.**
- 01A **To promote the use of uniform, understandable, and effective traffic control devices; to avoid varying official interpretations, and to facilitate the orderly development of traffic control policy, the State Traffic and Safety Engineer shall be the focal point for policy in all matters concerning the ATM.**
- A. **Official interpretations for purposes of Alaska Department of Transportation and Public Facilities' practice of these standards shall be made by the State Traffic and Safety Engineer.**
- B. **Those who desire interpretation of a clause in the ATM, a revision to the ATM, or permission to experiment with or use a traffic control device not in the ATM, ASDS, or the Alaska Department of Transportation and Public Facilities' Standard Drawings shall submit a written request to the State Traffic and Safety Engineer. The request shall clearly identify the existing standard (if any), and the proposed standard including a complete statement as to how and when it is to be applied, the date, and the name and address of the person making the request.**
- The State Traffic and Safety Engineer shall circulate requests for new traffic control devices and significant changes in policy that can be approved at the state level, such as revisions to text-only signs, to the Regional Traffic and Safety Engineers, the FHWA Alaska Division Safety/Operations Engineer, and the Anchorage and Fairbanks traffic engineers for their input. Responses to the requestor shall be sent within 60 days of receipt of the request.
- If the request is one that requires interim or experimental approval from the FHWA, the requestor shall send a letter to the State Traffic and Safety Engineer that addresses the requirements listed in

section 1A.10 of the MUTCD. Upon concurrence, the State Traffic and Safety Engineer shall send the request to the FHWA and distribute the response when received.

- C. Revisions to the MUTCD shall not become part of the ATM until they have been reviewed by the State Traffic and Safety Engineer, any necessary changes have been made to the ATMS, the FHWA has approved those changes, and the State Traffic and Safety Engineer informs users of the adoption of the revised MUTCD.

Section 1A.11 Relation to Other Publications

Standard:

- ⁰¹ To the extent that they are incorporated by specific reference, the latest editions of the following publications, or those editions specifically noted, shall be a part of this Manual: “Standard Highway Signs and Markings (SHSM)” book (FHWA); and “Color Specifications for Retroreflective Sign and Pavement Marking Materials” (appendix to subpart F of Part 655 of Title 23 of the Code of Federal Regulations).
- ^{01A} The “Alaska Sign Design Specifications (ASDS)” shall be the source document for all signs in the ATM. Where the SHSM is referenced in MUTCD Parts 2 through 9, the reference shall instead be to the ASDS.

Section 1A.12 Color Code

Support:

- ⁰¹ The following color code establishes general meanings for 11 colors of a total of 13 colors that have been identified as being appropriate for use in conveying traffic control information. tolerance limits for each color are contained in 23 CFR Part 655, Appendix to Subpart F and are available at the Federal Highway Administration’s MUTCD website at <http://mutcd.fhwa.dot.gov> or by writing to the FHWA, Office of Safety Research and Development (HRD-T-301), 6300 Georgetown Pike, McLean, VA 22101.
- ⁰² The two colors for which general meanings have not yet been assigned are being reserved for future applications that will be determined only by FHWA after consultation with the States, the engineering community, and the general public. The meanings described in this Section are of a general nature. More specific assignments of colors are given in the individual Parts of this Manual relating to each class of devices.

Standard:

- ⁰³ The general meaning of the 13 colors shall be as follows:
- A. Black—regulation
 - B. Blue—road user services guidance, tourist information, and evacuation route
 - C. Brown—recreational and cultural interest area guidance
 - D. Coral—unassigned
 - E. Fluorescent Pink—incident management
 - F. Fluorescent Yellow-Green—~~pedestrian warning, bicycle warning, playground warning, school bus and school warning~~
All school warning signs shall have fluorescent yellow-green backgrounds, except SCHOOL BUS STOP AHEAD signs (S3-1 or S3-100).
 - G. Green—indicated movements permitted, direction guidance
 - H. Light Blue—unassigned
 - I. Orange—temporary traffic control
 - J. Purple—lanes restricted to use only by vehicles with registered electronic toll collection (ETC) accounts
 - K. Red—stop or prohibition
 - L. White—regulation
 - M. Yellow—warning, pedestrian warning, bicycle warning, and playground warning

Option:

- ^{03A} Fluorescent Yellow-Green may be used for pedestrian warning, bicycle warning, and playground warning signs posted within a designated school zone.
- ^{03B} SCHOOL BUS STOP AHEAD (S3-1 or S3-100) signs may have either a yellow or fluorescent yellow-green background.

Section 1A.13 Definitions of Headings, Words, and Phrases in this Manual

Standard:

⁰¹ When used in this Manual, the text headings of Standard, Guidance, Option, and Support shall be defined as follows:

- A. **Standard**—a statement of required, mandatory, or specifically prohibitive practice regarding a traffic control device. All Standard statements are labeled, and the text appears in bold type. The verb “shall” is typically used. The verbs “should” and “may” are not used in Standard statements. Standard statements are sometimes modified by Options. ~~Standard statements shall not be modified or compromised based on engineering judgment or engineering study.~~
- B. **Guidance**—a statement of recommended, but not mandatory, practice in typical situations, with deviations allowed if engineering judgment or engineering study indicates the deviation to be appropriate. All Guidance statements are labeled, and the text appears in unbold type. The verb “should” is typically used. The verbs “shall” and “may” are not used in Guidance statements. Guidance statements are sometimes modified by Options.
- C. **Option**—a statement of practice that is a permissive condition and carries no requirement or recommendation. Option statements sometime contain allowable modifications to a Standard or Guidance statement. All Option statements are labeled, and the text appears in unbold type. The verb “may” is typically used. The verbs “shall” and “should” are not used in Option statements.
- D. **Support**—an informational statement that does not convey any degree of mandate, recommendation, authorization, prohibition, or enforceable condition. Support statements are labeled, and the text appears in unbold type. The verbs “shall,” “should,” and “may” are not used in Support statements.

⁰² Unless otherwise defined in this Section, or in other Parts of this Manual, words or phrases shall have the meaning(s) as defined in the most recent editions of the “Uniform Vehicle Code,” “AASHTO Transportation Glossary (Highway Definitions),” and other publications mentioned in Section 1A.11.

⁰³ The following words and phrases, when used in this Manual, shall have the following meanings:

[Note: Definitions 1 through 93 are unmodified by this ATMS.]

94. Intersection—intersection is defined as follows:

- (a) The area embraced within the prolongation or connection of the lateral curb lines, or if none, the lateral boundary lines of the roadways of two highways that join one another at, or approximately at, right angles, or the area within which vehicles traveling on different highways that join at any other angle might come into conflict.
- (b) The junction of ~~an alley or~~ a driveway with a roadway or highway shall not constitute an intersection, unless the roadway or highway at said junction is controlled by a traffic control device. The junction of an alley with a street or highway is not an intersection (13 AAC 40.010).
- (c) If a highway includes two roadways that are 30 feet or more apart (see definition of Median), then every crossing of each roadway of such divided highway by an intersecting highway shall be a separate intersection.
- (d) If both intersecting highways include two roadways that are 30 feet or more apart, then every crossing of any two roadways of such highways shall be a separate intersection.
- ~~(e) At a location controlled by a traffic control signal, regardless of the distance between the separate intersections as defined in (c) and (d) above:
 - (1) If a stop line, yield line, or crosswalk has not been designated on the roadway (within the median) between the separate intersections, the two intersections and the roadway (median) between them shall be considered as one intersection;
 - (2) Where a stop line, yield line, or crosswalk is designated on the roadway on the intersection approach, the area within the crosswalk and/or beyond the designated stop line or yield line shall be part of the intersection; and
 - (3) Where a crosswalk is designated on a roadway on the departure from the intersection, the intersection shall include the area extending to the far side of such crosswalk.~~

[Note: Definitions 95 through 184 are unmodified by this ATMS.]

185. School Zone—a designated roadway segment approaching, adjacent to, and beyond school buildings

or grounds, or along which school related activities occur. School zones, when designated, may have a reduced speed limit, increased fines for speeding or other traffic violations within the zone, and/or a designated school crossing.

[Note: Definitions 186 through 241 are unmodified by this ATMS.]

- 242. Traveled Way**—the portion of the roadway for the movement of vehicles, exclusive of the shoulders, berms, sidewalks, and parking lanes. On two-lane gravel roads or paved roads without striping, the traveled way is considered the 24-foot area centered between hinge points. If the distance between hinge points is 24 feet or less, the traveled way shall be considered 20 feet wide in placement of traffic control devices.

[Note: Definitions 243 through 259 are unmodified by this ATMS.]

[Note: Definitions 260 through 299 are reserved for future MUTCD definitions.]

- 300. Alaska Sign Design Specifications**—The “Alaska Sign Design Specifications (ASDS)” contains drawings showing dimensions, shapes, colors, and other information necessary for laying out the signs that are used in Alaska. The ASDS consists of the “Standard Highway Signs and Markings” book (FHWA) and the “Alaska Sign Design Specifications Supplement”.
- 301. Alaska Traffic Manual**—The Alaska Traffic Manual (ATM) consists of the 2009 Edition of the Manual on Uniform Traffic Control Devices (MUTCD) dated December 2009, and this Alaska Traffic Manual Supplement (ATMS).
- 302. City Traffic Engineer**—An employee of a local government agency with road jurisdiction who is responsible for traffic control devices.
- 303. Commissioner**—All references to the commissioner herein, not otherwise identified, shall refer to the Commissioner of the Alaska Department of Transportation and Public Facilities; the commissioner’s duly authorized agents, representatives, and assigns; and those who by nature of their regular duties or emergency situations are required to act in matters of policy concerning traffic control devices. “Duly authorized” in times of emergency does not relieve anyone of the responsibility of obtaining approvals and authority from the regular authority when the emergency has passed.
- 304. Hinge Point**—The angle point where the top surface of a road intersects a foreslope, typically at the outside edge of the shoulder.
- 305. Regional Traffic and Safety Engineer (RTSE)** —One of three DOT&PF employees with this title. There is one RTSE in the Northern Region (based in Fairbanks), one in the Central Region (based in Anchorage), and one in the Southeast Region (based in Juneau).
- 306. School Area**—The neighborhood and spaces surrounding and including a school and its grounds, including the road and non-road portions of the space. A school area may or may not include a designated school zone.
- 307. Shoulder**—That portion of the roadway outside of the traveled way. Left shoulders on divided roadways are considered part of the median. Shoulders should normally be considered refuge or emergency lanes rather than parking areas.
- 308. State Highways**—All public vehicular ways designated as state highways in accordance with Title 19 of the Alaska Statutes.
- 309. State-Maintained Roads**—The roads maintained by state forces or maintained by others at state expense.
- 310. State Traffic and Safety Engineer (STSE)**—The individual with this title is employed by the Design and Construction Standards Section of the Design and Engineering Services Division of DOT&PF in Juneau.

(This page left intentionally blank.)

PART 2

SIGNS

CHAPTER 2A. GENERAL

Section 2A.06 Design of Signs

Support:

- 01 This Manual shows many typical standard signs and object markers approved for use on streets, highways, bikeways, and pedestrian crossings.
- 02 In the specifications for individual signs and object markers, the general appearance of the legend, color, and size are shown in the accompanying tables and illustrations, and are not always detailed in the text.
- 03 Detailed drawings of standard signs, object markers, alphabets, symbols, and arrows (see Figure 2D-2) are shown in the ~~“Standard Highway Signs and Markings” book~~ “Alaska Sign Design Specifications”. ~~Section 1A.11 contains information regarding how to obtain this publication.~~
- 04 The basic requirements of a sign are that it be legible to those for whom it is intended and that it be understandable in time to permit a proper response. Desirable attributes include:
 - A. High visibility by day and night; and
 - B. High legibility (adequately sized letters, symbols, or arrows, and a short legend for quick comprehension by a road user approaching a sign).
- 05 Standardized colors and shapes are specified so that the several classes of traffic signs can be promptly recognized. Simplicity and uniformity in design, position, and application are important.
- 05A The material specifications for traffic control devices for use on state highways are specified in the Alaska DOT&PF “Standard Specifications for Highway Construction”, latest edition.

Section 2A.10 Sign Colors

[Revise Table 2A-5 of the 2009 MUTCD to add “*****” next to the X’s under Fluorescent Yellow-Green for pedestrian and bicycle warning signs. Add the following note: ***** The fluorescent yellow-green background color may be applied to pedestrian and bicycle signs in school areas (See Section 1A.12).]

Section 2A.12 Symbols

Standard:

- 01 **Symbol designs shall in all cases be unmistakably similar to those shown in this Manual and in the “Standard Highway Signs and Markings” book (see Section 1A.11).**

Support:

- 02 New symbol designs are adopted by the Federal Highway Administration based on research evaluations to determine road user comprehension, sign conspicuity, and sign legibility.
- 03 Sometimes a change from word messages to symbols requires significant time for public education and transition. Therefore, this Manual sometimes includes the practice of using educational plaques to accompany new symbol signs.

Guidance:

- 04 *New warning or regulatory symbol signs not readily recognizable by the public should be accompanied by an educational plaque.*

Option:

- 05 Educational plaques may be left in place as long as they are in serviceable condition.
- 06 State and/or local highway agencies may conduct research studies to determine road user comprehension, sign conspicuity, and sign legibility.

Guidance:

07 *Although most standard symbols are oriented facing left, mirror images of these symbols should be used where the reverse orientation might better convey to road users a direction of movement.*

Standard:

08 **A symbol used for a given category of signs (regulatory, warning, or guide) shall not be used for a different category of signs, except as specifically authorized in this Manual.**

09 **Except as provided in Paragraph 11, a recreational and cultural interest area symbol (see Chapter 2M) shall not be used on streets or highways outside of recreational and cultural interest areas.**

10 **A recreational and cultural interest area guide sign symbol (see Chapter 2M) shall not be used on any regulatory or warning sign on any street, road, or highway.**

Option:

11 A recreational and cultural interest area guide sign symbol (see Section 2M.04) may be used on a highway guide sign outside of a recreational and cultural interest area to supplement a comparable word message for which there is no approved symbol for that message in Chapters 2B through 2I or 2N.

Support:

12 Section 2M.07 contains provisions for the use of recreational and cultural interest area symbols to indicate prohibited activities or items in non-road applications.

Guidance:

12A *Whenever the ATM allows a choice of symbols or words to convey a sign message, the symbol should be used. As older signs are replaced under routine maintenance operations, symbol signs should be installed.*

Section 2A.16 Standardization of Location

Support:

01 Standardization of position cannot always be attained in practice. Examples of heights and lateral locations of signs for typical installations are illustrated in Figure 2A-2, and examples of locations for some typical signs at intersections are illustrated in Figures 2A-3 and 2A-4.

02 Examples of advance signing on an intersection approach are illustrated in Figure 2A-4. Chapters 2B, 2C, and 2D contain provisions regarding the application of regulatory, warning, and guide signs, respectively.

Standard:

03 **Signs requiring separate decisions by the road user shall be spaced sufficiently far apart for the appropriate decisions to be made. One of the factors considered when determining the appropriate spacing shall be the posted or 85th-percentile speed.**

Guidance:

04 *Signs should be located on the right-hand side of the roadway where they are easily recognized and understood by road users. Signs in other locations should be considered only as supplementary to signs in the normal locations, except as otherwise provided in this Manual.*

05 *Signs should be individually installed on separate posts or mountings except where:*

- A. *One sign supplements another;*
- B. *Route or directional signs are grouped to clarify information to motorists;*
- C. *Regulatory signs that do not conflict with each other are grouped, such as turn prohibition signs posted with one way signs or a parking regulation sign posted with a speed limit sign; or*
- D. *Street name signs are posted with a stop or yield sign.*

06 *Signs should be located so that they:*

- A. *Are outside the clear zone unless placed on a breakaway or yielding support (see Section 2A.19),*
- B. *Optimize nighttime visibility,*
- C. *Minimize the effects of mud splatter and debris,*
- D. *Do not obscure each other,*
- E. *Do not obscure the sight distance to approaching vehicles on the major street for drivers who are stopped on minor-street approaches, and*

F. *Are not hidden from view.*

Support:

07 The clear zone is the total roadside border area, starting at the edge of the traveled way, available for use by errant vehicles. The width of the clear zone is dependent upon traffic volumes, speeds, and roadside geometry. Additional information can be found in AASHTO's "Roadside Design Guide" (see Section 1A.11).

Guidance:

08 *With the increase in traffic volumes and the desire to provide road users regulatory, warning, and guidance information, an order of priority for sign installation should be established.*

Support:

09 An order of priority is especially critical where space is limited for sign installation and there is a demand for several different types of signs. Overloading road users with too much information is not desirable.

Guidance:

10 *Because regulatory and warning information is more critical to the road user than guidance information, regulatory and warning signing whose location is critical should be displayed rather than guide signing in cases where conflicts occur. Community wayfinding and acknowledgment guide signs should have a lower priority as to placement than other guide signs. Information of a less critical nature should be moved to less critical locations or omitted.*

Standard:

10A See Section 2A.100 for order of priority for sign installation.

Section 2A.18 Mounting Height

Standard:

14 **Overhead signs, not including signs on traffic signal mast arms, shall provide a vertical clearance of not less than ~~17~~ 18.5 feet to the sign, light fixture, or sign bridge over the entire width of the pavement and shoulders except where the structure on which the overhead signs are to be mounted or other structures along the roadway near the sign structure have a lesser vertical clearance. Where clearance is restricted to less than 18.5 feet by the structure a sign is mounted on, the sign shall be mounted as low as is practical without further restricting clearance. Signs mounted on traffic signal mast arms shall provide a vertical clearance of not less than 17.5 feet.**

Option:

15 If the vertical clearance of other structures along the roadway near the sign structure is less than 16 feet, the vertical clearance to an overhead sign structure or support may be as low as 1 foot higher than the vertical clearance of the other structures in order to improve the visibility of the overhead signs.

16 In special cases it may be necessary to reduce the clearance to overhead signs because of substandard dimensions in tunnels and other major structures such as double-deck bridges.

Support:

17 Figure 2A-2 illustrates some examples of the mounting height requirements contained in this Section.

[Revise Figure 2A-2(H) to show 17.5 feet minimum for signal mast arms and 18.5 feet minimum for other overhead signs.]

Section 2A.20 Orientation

Guidance:

01 *Unless otherwise provided in this Manual, signs should be vertically mounted at approximately right angles to the direction of, and facing, the traffic that they are intended to serve.*

02 *Where mirror reflection from the sign face is encountered to such a degree as to reduce legibility, the sign should be turned slightly away from the road. Signs that are placed 30 feet or more from the pavement edge should be turned toward the road. On curved alignments, the angle of placement should be determined by the direction of approaching traffic rather than by the roadway edge at the point where the sign is located.*

^{02A} *The face of all overhead signs should be tilted at least 3 degrees downward to reduce the amount of dirt, dust, snow, and bird droppings that would otherwise build up on the face of a sign.*

Option:

⁰³ On grades, sign faces may be tilted forward or back from the vertical position to improve the viewing angle.

Section 2A.100 Directional and Service Signing

[This is a new section. There is no corresponding section in the MUTCD.]

[Section 2A.24 through 2A.99 are reserved for future MUTCD use.]

Support:

^{01A} Table 2A-101 provides a quick reference summary of the signs used in Alaska to direct travelers to roads, destinations, and services.

Standard:

^{02A} **When signs compete for roadside space, place those with the highest priority, as shown in Table 2A-101, first.**

^{03A} **Only permanent signs have been prioritized. Where possible, place temporary traffic control signs where they do not interfere with permanent signs.**

^{04A} **Reference the Alaska Administrative Code (AAC) for information about all signs that have an AAC reference listed under the “Regulation” column. Regulation information is not duplicated in this publication.**

Table 2A-101. Summary of Directional / Service Signs

Sign Type	Sign No(s) from ASDS	Purpose	Color	Priority	Applicable References		Allowed on Expwy or Fwy?	Permit Available?	Remarks
					Regulation	ATM			
Guide, Conventional Roads	D1 to D11 excluding signs below	Direction to roads and destinations	White on Green	4	n/a	2D	No	No	
Guide, Freeway & Expressway	E1 to E11	Direction to roads and destinations	White on Green	4	n/a	2E	Yes	No	
General Service	D9-1 to D9-308	Direction to generic services	White on Blue	5	n/a	2I	Expy OK Fwy No	No	
General Information	I-1 to I-181	Identification of roadside points of Interest	White on Blue	6	n/a	2H	Yes	No	
RCIA	D7-1 to D7-105	Direction to recreational or cultural points of interest	White on Brown	7	17 AAC 60.201 to .215	2M	Yes	Yes	See regulation for permit requirements
Community Service	D9-204	Direction to communities and identification of services	White on Blue	8	n/a	2D.100	Yes	No	May be installed where TODS, RCIA, or LOGO signs are too numerous
Specific Service – LOGO	LG-C1 to LG-G3	Direction to services identified by business symbol or name	White on Blue	9	17 AAC 60.101 to .120	2J	Yes	Yes	See regulation for permit requirements
Tourist-Oriented Directional Signs (TODS)	D9-205	Direction to businesses identified by business name	White on Blue	10	17 AAC 60.001 to .020	2K	No	Yes	See regulation for permit requirements
Traveler Information Kiosks (not traffic control devices)	n/a	Direction to community services (signs not visible from road)	No sign color specified	n/a	17 AAC 60.401 to .420	n/a	In turnouts only	Yes	See reg. for permit rqmts. May be installed where TODS, RCIA, or LOGO signs are too numerous.

* Priorities shown in the table begin with Priority #4 because regulatory, warning, and school signs (not shown in table) have the top three priorities, not necessarily in that order. Sign precedence for regulatory, warning, and school signs shall be determined based on the specifics of each case.

CHAPTER 2B. REGULATORY SIGNS, BARRICADES, AND GATES

Section 2B.03 Size of Regulatory Signs

Standard:

01 Except as provided in Section 2A.11, the sizes for regulatory signs shall be as shown in Table 2B-1.

Support:

02 Section 2A.11 contains information regarding the applicability of the various columns in Table 2B-1.

Standard:

03 Except as provided in Paragraphs 4 and 5, the minimum sizes for regulatory signs facing traffic on multi-lane conventional roads shall be as shown in the Multi-lane column of Table 2B-1.

Option:

04 Where the posted speed limit is 35 mph or less on a multi-lane highway or street, other than for a STOP sign, the minimum size shown in the Single Lane column in Table 2B-1 may be used.

05 Where a regulatory sign, other than a STOP sign, is placed on the left-hand side of a multi-lane roadway in addition to the installation of the same regulatory sign on the right-hand side of the roadway, the size shown in the Single Lane column in Table 2B-1 may be used for both the sign on the right-hand side and the sign on the left-hand side of the roadway.

Standard:

06 A minimum size of 36 x 36 inches shall be used for STOP signs that face multi-lane approaches.

07 Where side roads intersect a multi-lane street or highway that has a speed limit of 45 mph or higher, the minimum size of the STOP signs facing the side road approaches, even if the side road only has one approach lane, shall be 36 x 36 inches.

08 Where side roads intersect a multi-lane street or highway that has a speed limit of 40 MPH or lower, the minimum size of the STOP signs facing the side road approaches shall be as shown in the Single Lane or Multi-lane columns of Table 2B-1 based on the number of approach lanes on the side street approach.

Guidance:

09 *The minimum sizes for regulatory signs facing traffic on exit and entrance ramps at major intersections connecting an Expressway or Freeway with an Expressway or Freeway (see Section 2E.32A (a)) should be as shown in the column of Table 2B-1 that corresponds to the mainline roadway classification (Expressway or Freeway). If a minimum size is not provided in the Freeway column, the minimum size in the Expressway column should be used. If a minimum size is not provided in the Freeway or Expressway Column, the size in the Oversized column should be used.*

09A *The minimum size for all regulatory signs facing traffic on exit and entrance ramps at all other interchanges (see Section 2E.32A (b) B and C) should be the regulatory sign size shown in Table 2B-1 Conventional Road Single Lane column for single lane ramps and Multi-lane column for multi-lane ramps.*

[Remove from Table 2B-1 Regulatory Sign and Plaque Sizes references to signs R1-6a and R1-9a and rows corresponding with signs R5-4 and R10-17a.]

[Remove signs R1-6a and R1-9a from Figure 2B-2 Unsignalized Pedestrian Crosswalk Signs.]

Section 2B.12 In-Street and Overhead Pedestrian Crossing Signs (R1-6, R1-6a, R1-9, and R1-9a)

Option:

01 The In-Street Pedestrian Crossing (R1-6 ~~or R1-6a~~) sign (see Figure 2B-2) or the Overhead Pedestrian Crossing (R1-9 ~~or R1-9a~~) sign (see Figure 2B-2) may be used to remind road users of laws regarding right-of-way at an unsignalized pedestrian crosswalk. The legend STATE LAW may be displayed at the top of the R1-6, ~~R1-6a~~, and R1-9, ~~and R1-9a~~ signs, if applicable. On the R1-6 ~~and R1-6a~~ signs sign, the legend ~~legends STOP or YIELD~~ may be used instead of the ~~appropriate STOP sign or YIELD sign symbol~~.

02 Highway agencies may develop and apply criteria for determining the applicability of In-Street Pedestrian Crossing signs.

Standard:

- 03 **If used, the In-Street Pedestrian Crossing sign shall be placed in the roadway at the crosswalk location on the center line, on a lane line, or on a median island. The In-Street Pedestrian Crossing sign shall not be post-mounted on the left-hand or right-hand side of the roadway.**
- 04 **If used, the Overhead Pedestrian Crossing sign shall be placed over the roadway at the crosswalk location.**
- 05 **An In-Street or Overhead Pedestrian Crossing sign shall not be placed in advance of the crosswalk to educate road users about the State law prior to reaching the crosswalk, nor shall it be installed as an educational display that is not near any crosswalk.**

Guidance:

- 05A *The In-Street Pedestrian Crossing sign should not be used on roadways with a posted speed limit of greater than 35 mph.*
- 06 *If an island (see Chapter 3I) is available, the In-Street Pedestrian Crossing sign, if used, should be placed on the island.*

Option:

- 07 *If a Pedestrian Crossing (W11-2) warning sign is used in combination with an In-Street or an Overhead Pedestrian Crossing sign, the W11-2 sign with a diagonal downward pointing arrow (W16-7P) plaque may be post-mounted on the right-hand side of the roadway at the crosswalk location.*

Standard:

- 08 **The In-Street Pedestrian Crossing sign and the Overhead Pedestrian Crossing sign shall not be used at signalized locations.**
- 09 **The STOP FOR legend shall not be used in Alaska. ~~only be used in States where the State law specifically requires that a driver must stop for a pedestrian in a crosswalk.~~**
- 10 **The In-Street Pedestrian Crossing sign shall have a black legend (except for the red STOP or YIELD sign symbols) and border on a white background, surrounded by an outer yellow or, in a school zone, a fluorescent yellow-green background area (see Figure 2B-2). The Overhead Pedestrian Crossing sign shall have a black legend and border on a yellow or, in a school zone, a fluorescent yellow-green background at the top of the sign and a black legend and border on a white background at the bottom of the sign (see Figure 2B-2).**
- 11 **Unless the In-Street Pedestrian Crossing sign is placed on a physical island, the sign support shall be designed to bend over and then bounce back to its normal vertical position when struck by a vehicle.**

Support:

- 12 *The Provisions of Section 2A.18 concerning mounting height are not applicable for the In-Street Pedestrian Crossing sign.*

Standard:

- 13 **The top of an In-Street Pedestrian Crossing sign shall be a maximum of 4 feet above the pavement surface. The top of an In-Street Pedestrian Crossing sign placed in an island shall be a maximum of 4 feet above the island surface.**

Option:

- 14 *The In-Street Pedestrian Crossing sign may be used seasonably to prevent damage in winter because of plowing operations, and may be removed at night if the pedestrian activity at night is minimal.*
- 15 *In-Street Pedestrian Crossing signs, Overhead Pedestrian Crossing signs, and Yield Here To (Stop Here For) Pedestrians signs may be used together at the same crosswalk.*

Guidance:

- 15A *If an In-Street Pedestrian Crossing sign is not permanently installed, a maintenance agreement should be developed with the highway authority.*

Section 2B.13 Speed Limit Sign (R2-1)

[Remove sign R2-3P from Figure 2B-3 Speed Limit and Photo Enforcement Signs and Plaques.]

Standard:

- 00A **Speed limits on state highways shall be set in accordance with DOT&PF Policy and Procedure 05.05.020.**
- 01 **Speed zones (other than statutory speed limits) shall only be established on the basis of an engineering study that has been performed in accordance with traffic engineering practices. The engineering study shall include an analysis of the current speed distribution of free-flowing vehicles.**
- 02 **The Speed Limit (R2-1) sign (see Figure 2B-3) shall display the limit established by law, ordinance, regulation, or as adopted by the authorized agency based on the engineering study. The speed limits displayed shall be in multiples of 5 mph.**
- 03 **Speed Limit (R2-1) signs, indicating speed limits for which posting is required by law, shall be located at the points of change from one speed limit to another.**
- 04 **At the downstream end of the section to which a speed limit applies, a Speed Limit sign showing the next speed limit shall be installed. Additional Speed Limit signs shall be installed beyond major intersections and at other locations where it is necessary to remind road users of the speed limit that is applicable.**
- 05 **Speed Limit signs indicating the statutory speed limits shall be installed at entrances to the State and, where appropriate, at jurisdictional boundaries in urban areas.**

Support:

- 06 In general, the maximum speed limits applicable to rural and urban roads are established:
- A. Statutorily – a maximum speed limit applicable to a particular class of road, such as freeways or city streets, that is established by State law; or
 - B. As altered speed zones – based on engineering studies.
- 07 State statutory limits might restrict the maximum speed limit that can be established on a particular road, notwithstanding what an engineering study might indicate.

Option:

- 08 If a jurisdiction has a policy of installing Speed Limit signs in accordance with statutory requirements only on the streets that enter a city, neighborhood, or residential area to indicate the speed limit that is applicable to the entire city, neighborhood, or residential area unless otherwise posted, a CITYWIDE (R2-5aP), NEIGHBORHOOD (R2-5bP), or RESIDENTIAL (R2-5cP) plaque may be mounted above the Speed Limit sign and an UNLESS OTHERWISE POSTED (R2-5P) plaque may be mounted below the Speed Limit sign (see Figure 2B-3).

Guidance:

- 09 *A Reduced Speed Limit Ahead (W3-5 or ~~W3-5a~~) sign (see Section 2C.38) should be used to inform road users of a reduced speed zone where the speed limit is being reduced by more than 10 mph, or where engineering judgment indicates the need for advance notice to comply with the posted speed limit ahead.*

Option *Guidance*:

- 10 States and local agencies ~~should~~ may conduct engineering studies to reevaluate non-statutory speed limits on segments of their roadways that have undergone significant changes since the last review, such as the addition or elimination of parking, ~~or~~ significant changes in driveways density or use, changes in the number of travel lanes, changes in the configuration of bicycle lanes, major changes in traffic control signal coordination, or significant changes in major street traffic volumes.

Guidance:

- 11 *No more than three speed limits should be displayed on any one Speed Limit sign or assembly.*
- 12 *When a speed limit within a speed zone is posted, it should be within 5 mph of the 85th-percentile speed of free-flowing traffic.*
- 13 *Speed studies for signalized intersection approaches should be taken outside the influence area of the traffic control signal, which is generally considered to be approximately 1/2 mile, to avoid obtaining skewed results for the 85th-percentile speed.*

Support:

14 Advance warning signs and other traffic control devices to attract the motorist's attention to a signalized intersection are usually more effective than a reduced speed limit zone.

Guidance:

15 *An advisory speed plaque (see Section 2C.08) mounted below a warning sign should be used to warn road users of an advisory speed for a roadway condition. A Speed Limit sign should not be used for this situation.*

Option:

16 Other factors that may be considered when establishing or reevaluating speed limits are the following:

- A. Road characteristics, shoulder condition, grade, alignment, and sight distance;
- B. The pace;
- C. Roadside development and environment;
- D. Parking practices and pedestrian activity; and
- E. Reported crash experience for at least a 12-month period.

17 Two types of Speed Limit signs may be used: one to designate passenger car speeds, including any ~~nighttime information or~~ minimum speed limit that might apply; and the other to show any special speed limits for trucks and other vehicles.

18 A changeable message sign that changes the speed limit for traffic and ambient conditions may be installed provided that the appropriate speed limit is displayed at the proper times.

19 A changeable message sign that displays to approaching drivers the speed at which they are traveling may be installed in conjunction with a Speed Limit sign.

Guidance:

20 *If a changeable message sign displaying approach speeds is installed, the legend YOUR SPEED XX MPH or such similar legend should be displayed. The color of the changeable message legend should be a yellow legend on a black background or the reverse of these colors.*

Support:

21 Advisory Speed signs and plaques are discussed in Sections 2C.08 and 2C.14. Temporary Traffic Control Zone Speed signs are discussed in Part 6. The WORK ZONE (G20-5aP) plaque intended for installation above a Speed Limit sign is discussed in Section 6F.12. School Speed Limit signs are discussed in Section 7B.15.

Guidance:

21A *On state highways, speed limit signs should be located and spaced in accordance with DOT&PF Policy and Procedure 05.05.020.*

Option:

21B On multilane divided and multilane one-way roadways, speed limit signs may be installed on the left-hand side of the roadway to add emphasize to a speed limit sign installed on the right-hand side of the roadway.

Section 2B.15 Night Speed Limit Plaque (R2-3P)

Standard:

00A **Night Speed Limit signs shall not be used in Alaska.**

~~01 **Where different speed limits are prescribed for day and night, both limits shall be posted.**~~

~~Guidance:~~

~~02 *A Night Speed Limit (R2-3P) plaque (see Figure 2B-3) should be reversed using a white retroreflectorized legend and border on a black background.*~~

~~Option:~~

~~03 *A Night Speed Limit plaque may be combined with or installed below the standard Speed Limit (R2-1) sign.*~~

Section 2B.17 Higher Fines Signs and Plaque (R2-6P, R2-10, and R2-11)

Standard:

01 **If increased fines are imposed for traffic violations within a designated zone of a roadway, a BEGIN HIGHER FINES ZONE (R2-10) sign (see Figure 2B-3) or a FINES HIGHER (R2-6P) plaque (see Figure**

2B-3) shall be used to provide notice to road users. If used, the FINES HIGHER plaque shall be mounted below an applicable regulatory or warning sign in a temporary traffic control zone, a school zone, or other applicable designated zone.

01A When fines are increased in temporary traffic control zones in accordance with 17 AAC 99.010, the signs described in Section 6F.12 shall be used.

02 If an R2-10 sign or an R2-6P plaque is posted to provide notice of increased fines for traffic violations, an END HIGHER FINES ZONE (R2-11) sign (see Figure 2B-3) shall be installed at the downstream end of the zone to provide notice to road users of the termination of the increased fines zone.

Guidance:

03 If used, the BEGIN HIGHER FINES ZONE sign or FINES HIGHER plaque should be located at the beginning of the temporary traffic control zone, school zone, or other applicable designated zone and just beyond any interchanges, major intersections, or other major traffic generators.

Standard:

04 The Higher Fines signs and plaque shall have a black legend and border on a white rectangular background. All supplemental plaques mounted below the Higher Fines signs and plaque shall have a black legend and border on a white rectangular background.

Guidance:

05 Agencies should limit the use of the Higher Fines signs and plaque to locations where work is actually underway, or to locations where the roadway, shoulder, or other conditions, including the presence of a school zone and/or a reduced school speed limit zone, require a speed reduction or extra caution on the part of the road user.

Option:

06 Alternate legends such as BEGIN (or END) DOUBLE FINES ZONE may also be used for the R2-10 and R2-11 signs.

07 The legend FINES HIGHER on the R2-6P plaque may be replaced by FINES DOUBLE (R2-6aP), \$XX FINE (R2-6bP), or another legend appropriate to the specific regulation (see Figure 2B-3).

The following may be mounted below an R2-10 sign or R2-6P plaque:

- A. A supplemental plaque specifying the times that the higher fines are in effect (similar to the S4-1P plaque shown in Figure 7B-1), or
- B. A supplemental plaque WHEN CHILDREN (WORKERS) ARE PRESENT, or
- C. A supplemental plaque WHEN FLASHING (similar to the S4-4P plaque shown in Figure 7B-1) if used in conjunction with a yellow flashing beacon.

Support:

09 Section 6F.12 contains information regarding other signs and plaques associated with increased fines for traffic violations in temporary traffic control zones. Section 7B.10 contains information regarding other signs and plaques associated with increased fines for traffic violations in designated school zones.

Support:

09A The BEGIN HIGHWAY SAFETY ZONE TRAFFIC FINES DOUBLE (R16-112) and END DOUBLE TRAFFIC FINES (R16-101) signs legally establish the beginning and end of safety zones.

09B Safety Zones become effective when the Commissioner of the DOT&PF and Commissioner of the Department of Public Safety sign a Highway Safety Corridor Designation form.

Standard:

09C Safety zone (corridor) signing in accordance with AS 19.10.075 shall only be installed on rural, state-maintained roads that meet all the following conditions:

- A. Are designated as either
 1. an Interstate, or
 2. a rural major arterial, or
 3. a rural major collector with 2000 ADT or more, or
 4. a rural minor arterial with 2000 ADT or more.
- B. Have a three-year fatal+major injury incident rate per mile that exceeds 110% of the statewide average for rural arterials.
- C. Have a three-year fatal+major injury crash rate per 100 million vehicle miles that exceeds 110% of

the statewide average for rural arterials.

- D. The DOT&PF and the police agency with jurisdiction agree on a coordinated traffic control / traffic patrol plan.
- E. DOT&PF and the police agree the proposed safety zone will be effective in reducing highway crashes.
- F. The police agency with jurisdiction agrees to define the amount of enforcement needed to increase safe driver behavior in the safety zone, and to provide that enforcement on an ongoing basis.

^{09D} No more than ten safety zones shall exist in Alaska at one time.

Option:

^{09E} The DOT&PF may choose not to sign all road segments that meet the above criteria.

^{09F} Periods longer than three years (up to 5 years) may be used for incident and injury rates used for establishing safety zones.

Support:

^{09G} The two accident rates serve different purposes. The per-mile injury rate indicates crash concentration while the per-vehicle mile crash rate is an indication of correctability. If both thresholds are exceeded, safety countermeasures can be expected to significantly reduce crashes.

Guidance:

^{09H} Safety zones should include road segments of similar character and begin and end at logical locations. If a short non-qualifying segment exists between two qualifying segments, consider extending the zone across the non-qualifying segment. Zones should be no shorter than 5 miles.

Option:

^{09I} Safety zone signs may be removed if the DOT&PF and police agency with jurisdiction agree the safety zone is no longer effective or conditions have changed in a way that makes the safety zone unnecessary.

Standard:

^{09J} **BEGIN HIGHWAY SAFETY ZONE TRAFFIC FINES DOUBLE (R16-112) signs and SAFETY ZONE SPEED LIMIT (R2-101) signs shall be posted at the beginning of every safety zone, in that order.**

^{09K} **END DOUBLE FINES (R16-101) signs shall be posted at the end of every safety zone.**

^{09L} **All existing regulatory speed limit signs within the double fines zone shall either be replaced with SAFETY ZONE SPEED LIMIT (R2-101) signs or supplemented with SAFETY ZONE (R16-114) plates.**

^{09M} **When a double fine zone is longer than 3 miles, SAFETY ZONE SPEED LIMIT (R2-101) signs or standard SPEED LIMIT (R2-1) signs with SAFETY ZONE (R16-114) plates shall be posted at spacings not greater than 3 miles (+/- ½ mile) within the safety zone.**

^{09N} **SAFETY ZONE SPEED LIMIT (R2-101) signs or standard SPEED LIMIT (R2-1) signs with SAFETY ZONE (R16-114) plates shall be installed on the main street on either side of major intersections within safety zone.**

^{09O} **Install either SAFETY ZONE BEGIN DOUBLE TRAFFIC FINES (R16-113) or BEGIN HIGHWAY SAFETY ZONE TRAFFIC FINES DOUBLE (R16-112) signs on side streets entering the safety zone. These signs are only required on side streets functionally classified as collector or higher.**

Section 2B.30 KEEP RIGHT EXCEPT TO PASS Sign (R4-16) and SLOWER TRAFFIC KEEP RIGHT Sign (R4-3)

Option:

⁰¹ The KEEP RIGHT EXCEPT TO PASS (R4-16) sign (see Figure 2B-10) may be used on multi-lane roadways to direct drivers to stay in the right-hand lane except when they are passing another vehicle.

Guidance:

⁰² *If used, the KEEP RIGHT EXCEPT TO PASS sign should be installed just beyond the beginning of a multi-lane roadway and at selected locations along multi-lane roadways for additional emphasis. This sign should be omitted if the truck/passing lane is less than ½ mile long.*

Option:

- 03 The SLOWER TRAFFIC KEEP RIGHT (R4-3) sign (see Figure 2B-10) may be used on multi-lane roadways to reduce unnecessary lane changing.

Guidance:

- 04 *If used, the SLOWER TRAFFIC KEEP RIGHT sign should be installed just beyond the beginning of a multi-lane pavement, and at selected locations where there is a tendency on the part of some road users to drive in the left-hand lane (or lanes) below the normal speed of traffic. This sign should not be used on the approach to an interchange or through an interchange area.*

Section 2B.31 TRUCKS USE RIGHT LANE Sign (R4-5)

Guidance:

- 01 *If an extra lane has been provided for trucks and other slow-moving traffic, a SLOWER TRAFFIC KEEP RIGHT (R4-3) sign (see Figure 2B-10), TRUCKS USE RIGHT LANE (R4-5) sign (see Figure 2B-10), or other appropriate sign should be installed at the beginning of the lane.*

Option:

- 02 The SLOWER TRAFFIC KEEP RIGHT sign may be used as a supplement or as an alternative to the TRUCKS USE RIGHT LANE sign. Both signs may be used on multi-lane roadways to improve capacity and reduce lane changing.

- 03 The TRUCKS USE RIGHT LANE (R4-5) sign may be used on multi-lane roadways to reduce unnecessary lane changing.

Guidance:

- 04 *If an extra lane has been provided for trucks and other slow-moving traffic, a Lane Ends sign (see Section 2C.42) should be installed in advance of the point where the extra lane ends. Appropriate pavement markings should be installed at both the upstream and downstream ends of the extra lane (see ~~Section 3B.09 and Figure 3B-13~~ Figure 2B-100).*

Support:

- 05 Section 2D.51 contains information regarding advance information signs for extra lanes that have been provided for trucks and other slow-moving traffic.

Guidance:

- 05A *Signs and pavement markings for climbing and passing lanes should be installed as shown in Figure 2B-100.*

Figure 2B-100. Typical Signing/Striping for Truck/Passing Lanes

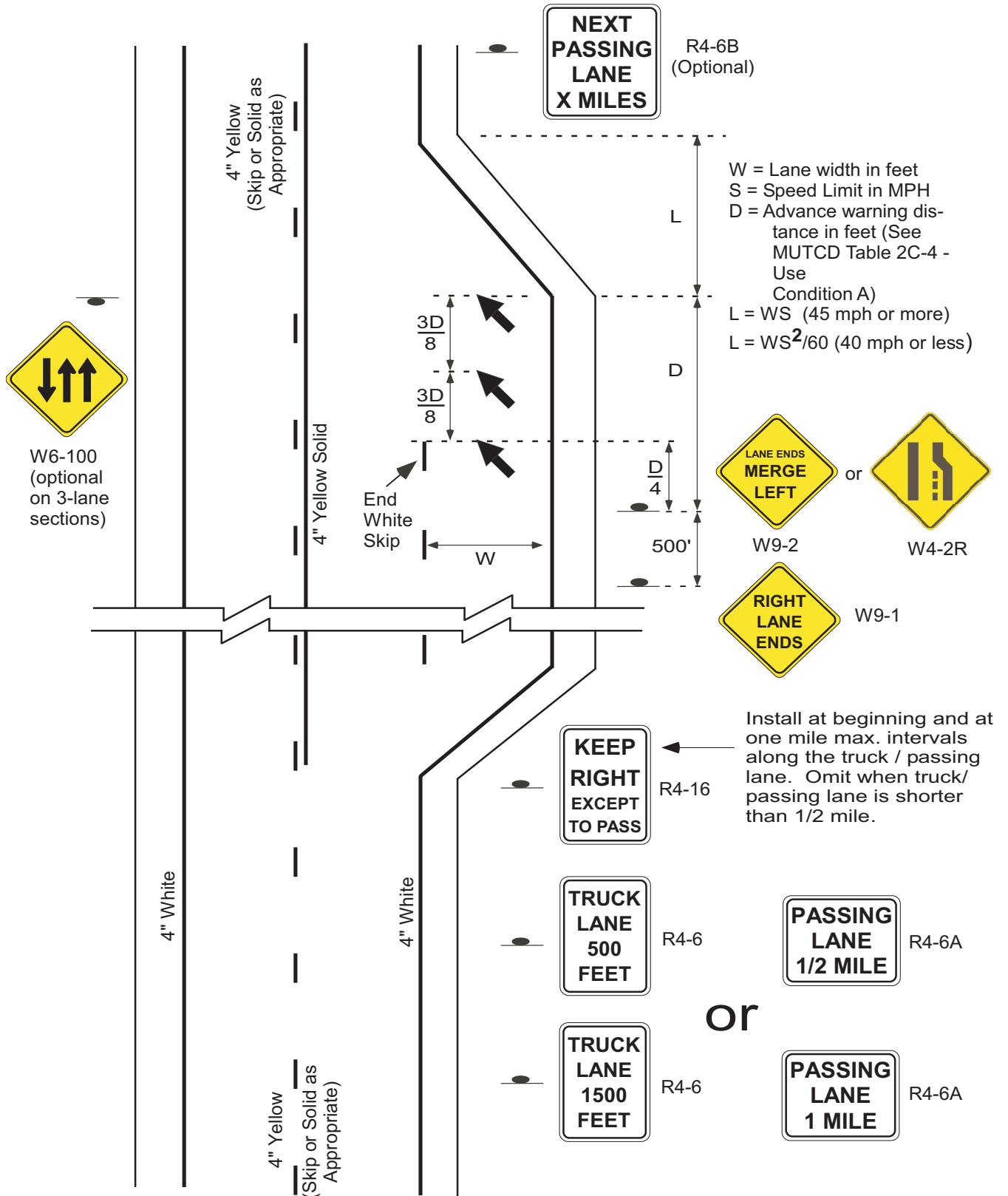

Section 2B.35 Slow Vehicle Turn-Out Signs (R4-12, R4-13, and R4-14, I-120, and I-122)

Support:

01 On two-lane highways in areas where traffic volumes and/or vertical or horizontal curvature make passing difficult, turn-out areas are sometimes provided for the purpose of giving a group of faster vehicles an opportunity to pass a slow-moving vehicle.

Standard:

01A **The signs in this section shall only be used to indicate turnouts to the right.**

Option:

02 A SLOW VEHICLES WITH ~~XX~~ 5 OR MORE FOLLOWING VEHICLES MUST USE TURN-OUT (R4-12) sign (see Figure 2B-10) may be installed on two-lane, rural state highways at locations determined by the regional traffic and safety engineer in advance of a turn-out area to inform drivers who are driving so slow that they have accumulated a ~~specific number of~~ five vehicles behind them that they are required by 13 AAC 02.050 ~~the traffic laws of that State~~ to use the turn-out to allow the vehicles following them to pass.

Guidance:

02A *These signs should only be placed on sections of highway where slow moving vehicle turnouts, meeting the requirements of the "DOT&PF Alaska Highway Preconstruction Manual," are periodically available.*

Support:

03 The specific number of vehicles displayed on the R4-12 sign provides law enforcement personnel with the information they need to enforce this regulation.

Option:

04 If an R4-12 sign has been installed in advance of a turn-out area, a SLOW VEHICLES MUST USE TURN-OUT AHEAD (R4-13) or SLOW VEHICLE TURNOUT XXX FT (I-122) sign (see Figure 2B-10) may also be installed downstream from the R4-12 sign, but upstream from the turn-out area, to remind slow drivers that they are required to use a turn-out that is a short distance ahead.

Guidance:

04A *The SLOW VEHICLES USE TURNOUTS NEXT XX MILES (I-120) should be used in addition to the other signs when multiple turnouts are available within a section of highway.*

Standard:

05 **If an R4-12 sign has been installed in advance of a turn-out area, a SLOW VEHICLES MUST TURN OUT (with arrow) (R4-14) sign (see Figure 2B-10) shall be installed at the entry point of the turn-out area.**

Guidance:

05A *NO PARKING (R8-3) signs should be installed within the turnout unless it is wide enough to allow movement through the turnout unimpeded by parked cars.*

Support:

06 Section 2D.52 contains information regarding advance information signs for slow vehicle turn-out areas.

Section 2B.39 Selective Exclusion Signs

[Remove sign R5-4 from Figure 2B-11 Selective Exclusion Signs.]

Support:

01 Selective Exclusion signs (see Figure 2B-11) give notice to road users that State or local statutes or ordinances exclude designated types of traffic from using particular roadways or facilities.

Standard:

02 **If used, Selective Exclusion signs shall clearly indicate the type of traffic that is excluded.**

Support:

- 03 Typical exclusion messages include:
- A. No Trucks (R5-2),
 - B. NO MOTOR VEHICLES (R5-3),
 - C. ~~NO COMMERCIAL VEHICLES (R5-4),~~
 - D. NO TRUCKS (VEHICLES) WITH LUGS (R5-5),
 - E. No Bicycles (R5-6),
 - F. NO NON-MOTORIZED TRAFFIC (R5-7),
 - G. NO MOTOR-DRIVEN CYCLES (R5-8),
 - H. No Pedestrians (R9-3),
 - I. No Skaters (R9-13),
 - J. No Equestrians (R9-14), and
 - K. No Hazardous Material (R14-3) (see Section 2B.62).

Option:

- 04 Appropriate combinations or groupings of these legends into a single sign, such as NO PEDESTRIANS BICYCLES MOTOR-DRIVEN CYCLES (R5-10a), or NO PEDESTRIANS OR BICYCLES (R5-10b) may be used.

Guidance:

- 05 *If an exclusion is governed by vehicle weight, a Weight Limit sign (see Section 2B.59) should be used instead of a Selective Exclusion sign.*
- 06 *If used on a freeway or expressway ramp, the NO PEDESTRIANS OR BICYCLES (R5-10b) sign should be installed in a location where it is clearly visible to any pedestrian or bicyclist attempting to enter the limited access facility from a street intersecting the exit ramp.*
- 07 *The Selective Exclusion sign should be placed on the right-hand side of the roadway at an appropriate distance from the intersection so as to be clearly visible to all road users turning into the roadway that has the exclusion. The NO PEDESTRIANS (R5-10c) or No Pedestrian Crossing (R9-3) sign (see Section 2B.51) should be installed so as to be clearly visible to pedestrians who are at a location where an alternative route is available.*

Option:

- 08 The NO PEDESTRIANS (R5-10c) or No Pedestrian Crossing (R9-3) sign may also be used at underpasses or elsewhere where pedestrian facilities are not provided.
- ~~09 The NO TRUCKS (R5-2a) word message sign may be used as an alternate to the No Trucks (R5-2) symbol sign.~~
- 10 The AUTHORIZED VEHICLES ONLY (R5-11) sign may be used at median openings and other locations to prohibit vehicles from using the median opening or facility unless they have special permission (such as law enforcement vehicles or emergency vehicles) or are performing official business (such as highway agency vehicles).

Standard:

- 10A **The COMMERCIAL VEHICLES EXCLUDED (R5-4) sign shall not be used in the State of Alaska.**

Option:

- 10B When an R5-2 No Trucks symbol sign is used, it shall be installed in the far right position at the last intersection where trucks may turn to avoid the prohibited street. A supplemental R5-2 sign may be necessary on the left side of the restricted roadway if additional emphasis is needed.

Guidance:

- 10C *A TRUCK ROUTE (R14-1 series) sign should be installed on the right, 500 feet or one-half block (whichever is less) in advance of the intersection where commercial vehicles must turn to avoid entering a restricted section of roadway. The R14-1 series signs should also be used in the same manner as trail markers to guide the trucker along the truck route unless other signing gives sufficient direction.*
- 10D *If used, the VEHICLES WITH LUGS PROHIBITED (R5-5) sign should be used to designate areas where pavement damage has occurred or is likely to occur due to vehicles with lugs traversing the pavement. Install the sign on the right where a vehicle with lugs can leave the roadway before arriving at the paved roadway.*

Section 2B.47 Design of Parking, Standing, and Stopping Signs

Support:

01 Discussions of parking signs and parking regulations in this Section apply not only to parking, but also to standing and stopping.

Standard:

02 **The legend on parking signs shall state applicable regulations. Parking signs (see Figures 2B-24 and 2B-25) shall comply with the standards of shape, color, and location.**

03 **Where parking is prohibited at all times or at specific times, the basic design for parking signs shall have a red legend and border on a white background (Parking Prohibition signs), except that the R8-4 and R8-7 signs and the alternate design for the R7-201aP plaque shall have a black legend and border on a white background, and the R8-3 sign shall have a black legend and border and a red circle and slash on a white background.**

04 **Where only limited-time parking or parking in a particular manner are permitted, the signs shall have a green legend and border on a white background (Permissive Parking signs).**

Guidance:

05 *Parking signs should display the following information from top to bottom of the sign, in the order listed:*

- A. *The restriction or prohibition;*
- B. *The times of the day that it is applicable, if not at all hours; and*
- C. *The days of the week that it is applicable, if not every day.*

06 *If the parking restriction applies to a limited area or zone, the limits of the restriction should be shown by arrows or supplemental plaques. If arrows are used and if the sign is at the end of a parking zone, there should be a single-headed arrow pointing in the direction that the regulation is in effect. If the sign is at an intermediate point in a zone, there should be a double-headed arrow pointing both ways. When a single sign is used at the transition point between two parking zones, it should display a right and left arrow pointing in the direction that the respective restrictions apply.*

07 *Where special parking restrictions are imposed during heavy snowfall, Emergency Snow Route (R7-203) signs (see Figure 2B-24) should be installed. The legend will vary according to the regulations, but the signs should be vertical rectangles, having a white background with the upper part of the plate a red background.*

Standard:

08 **Where parking spaces that are reserved for persons with disabilities are designated to accommodate wheelchair vans, a VAN ACCESSIBLE (R7-8P) plaque shall be mounted below the R7-8 sign. The R7-8 sign (see Figure 2B-24) shall have a green legend and border and a white wheelchair symbol on a blue square, all on a white background. The R7-8P plaque (see Figure 2B-24) shall have a green legend and border on a white background.**

Option:

09 To minimize the number of parking signs, blanket regulations that apply to a given district may, if legal, be posted at district boundary lines.

10 As an alternate to the use of arrows to show designated restriction zones, word messages such as BEGIN, END, HERE TO CORNER, HERE TO ALLEY, THIS SIDE OF SIGN, or BETWEEN SIGNS may be used.

11 Where parking is prohibited during certain hours and time-limited parking or parking in a particular manner is permitted during certain other time periods, the red Parking Prohibition and green Permissive Parking signs may be designed as follows:

- A. Two 12 x 18-inch parking signs may be used with the red Parking Prohibition sign installed above or to the left of the green Permissive Parking sign; or
- B. The red Parking Prohibition sign and the green Permissive Parking sign may be combined (see Figure 2B-24) to form an R7-200 sign on a single 24 x 18-inch sign, or an R7-200a sign on a single 12 x 30-inch sign.

12 At the transition point between two parking zones, a single sign or two signs mounted side by side may be used.

13 The words NO PARKING may be used as an alternative to the No Parking symbol. The supplemental educational plaque, NO PARKING, with a red legend and border on a white background, may be used above signs incorporating the No Parking symbol.

- 14 Alternate designs for the R7-107 sign may be developed such as the R7-107a sign (see Figure 2B-24). Alternate designs may include, on a single sign, a transit logo, an approved bus symbol, a parking prohibition, the words BUS STOP, and an arrow. The preferred bus symbol color is black, but other dark colors may be used. Additionally, the transit logo may be displayed on the bus face in the appropriate colors instead of placing the logo separately. The reverse side of the sign may contain bus routing information.
- 15 To make the parking regulations more effective and to improve public relations by giving a definite warning, a TOW-AWAY ZONE (R7-201P) plaque (see Figure 2B-24) may be appended to, or incorporated in, any parking prohibition sign. The Tow-Away Zone (R7-201aP) symbol plaque may be used instead of the R7-201P word message plaque. The R7-201aP plaque may have either a black or red legend and border on a white background.
- 15A R7-300 signs, “UNLESS YOU NEED VAN ACCESS PLEASE USE OTHER ACCESSIBLE SPACES FIRST”, may be used to encourage drivers with disabilities not to use van accessible parking spaces unless they need them.

Guidance:

- 16 *If a fee is charged for parking and a midblock pay station is used instead of individual parking meters for each parking space, pay parking signs should be used. Pay Parking (R7-22) signs (see Figure 2B-24) should be used to define the area where the pay station parking applies. Pay Station (R7-20) signs (see Figure 2B-24) should be used at the pay station or to direct road users to the pay station.*

Standard:

- 17 **If the pay parking is subject to a maximum time limit, the appropriate time limit (number of hours or minutes) shall be displayed on the Pay Parking (R7-21 or R7-21a) and Pay Station (R7-20) signs.**

Option:

- 18 In rural areas (see Figure 2B-25), the legends NO PARKING ON PAVEMENT (R8-1) or NO STOPPING ON PAVEMENT (R8-5) are generally suitable and may be used. If a roadway has paved shoulders, the NO PARKING EXCEPT ON SHOULDER sign (R8-2) or the NO STOPPING EXCEPT ON SHOULDER sign (R8-6) may be used as these signs would be less likely to cause confusion. The R8-3 symbol sign or the word message NO PARKING (R8-3a) sign may be used to prohibit any parking along a given highway. Word message supplemental plaques may be mounted below the R8-3 or R8-3a sign. These word message supplemental plaques may include legends such as EXCEPT SUNDAYS AND HOLIDAYS (R8-3bP), ON PAVEMENT (R8-3cP), ON BRIDGE (R8-3dP), ON TRACKS (R8-3eP), EXCEPT ON SHOULDERS (R8-3fP), LOADING ZONE (with arrow) (R8-3gP), and X:XX AM TO X:XX PM (with arrow) (R8-3hP).
- 19 Colors that are in compliance with the provisions of Section 2A.10 may be used for color coding of parking time limits.

Guidance:

- 20 *If colors are used for color coding of parking time limits, the colors green, red, and black should be the only colors that are used.*

Section 2B.48 Placement of Parking, Stopping, and Standing Signs

Guidance:

- 01 *When signs with arrows are used to indicate the extent of the restricted zones, the signs should be set at an angle of not less than 30 degrees or more than 45 degrees with the line of traffic flow in order to be visible to approaching traffic.*
- 02 *Spacing of signs should be based on legibility and sign orientation.*
- 03 *If the zone is unusually long, signs showing a double arrow should be used at intermediate points within the zone.*

Standard:

- 04 **If the signs are mounted at an angle of 90 degrees to the curb line, two signs shall be mounted back to back at the transition point between two parking zones, each with an appended THIS SIDE OF SIGN (R7-202P) supplemental plaque.**

Guidance:

- ⁰⁵ *If the signs are mounted at an angle of 90 degrees to the curb line, signs without any arrows or appended plaques should be used at intermediate points within a parking zone, facing in the direction of approaching traffic. Otherwise the standards of placement should be the same as for signs using directional arrows.*
- ^{05A} *NO STOPPING (R8 series) signs should not be used in combination with NO PARKING (R7 and R8 series) signs in the same zone. They should be used only where the full roadway is required for moving traffic and where there is no shoulder area for stopping outside the traffic stream.*

Section 2B.52 Traffic Signal Pedestrian and Bicycle Actuation Signs (R10-1 through R10-4, and R10-24 through R10-26)

Standard:

- ⁰¹ **Traffic Signal signs applicable to pedestrian actuation (see Figure 2B-26) or bicyclist actuation (see Figure 9B-2) shall be mounted immediately above or incorporated into the pushbutton detector units (see Section 4E.08).**

Support:

- ⁰² Traffic Signal signs applicable to pedestrians include:
- A. CROSS ONLY ON GREEN (symbolic circular green) (R10-1);
 - B. CROSS ONLY ON (symbolic walk indication) SIGNAL (R10-2);
 - C. Push Button for Walk Signal (R10-3 series); ~~and~~
 - D. Push Button for Green Signal (R10-4 series).; and
 - E. Meaning of Pedestrian Indications (R10-101).

Guidance:

- ^{02A} *The R10-3e or R10-3i sign should be used when pedestrian pushbutton units are provided. If pedestrian pushbutton units are not provided, the R10-101, Meaning of Pedestrian Indications, sign or sticker should be used.*

Option:

- ⁰³ The following signs may be used as an alternate for the R10-3 and R10-4 signs:
- A. Push Button to Cross Street Wait for Walk Signal (R10-3a); or
 - B. Push Button to Cross Street Wait for Green Signal (R10-4a).
- ⁰⁴ The name of the street to be crossed may be substituted for the word STREET in the legends on the R10-3a and R10-4a signs.

Guidance:

- ⁰⁵ *The finger in the pushbutton symbol on the R10-3, R10-3a, R10-4, and R10-4a signs should point in the same direction as the arrow on the sign.*

Option:

- ⁰⁶ Where symbol-type pedestrian signal indications are used, an educational sign (R10-3b) may be used instead of the R10-3 sign to improve pedestrian understanding of pedestrian indications at signalized intersections. Where word-type pedestrian signal indications are being retained for the remainder of their useful service life, the legends WALK/DONT WALK may be substituted for the symbols on the educational sign R10-3b, thus creating educational sign R10-3c. The R10-3d educational sign may be used to inform pedestrians that the pedestrian clearance time is sufficient only for the pedestrian to cross to the median at locations where pedestrians cross in two stages using a median refuge island. The R10-3e educational sign may be used where countdown pedestrian signals have been provided. In order to assist the pedestrian in understanding which pushbutton to push, the R10-3f to R10-3i educational signs that provide the name of the street to be crossed may be used instead of the R10-3b to R10-3e educational signs.
- ⁰⁷ The R10-24 or R10-26 sign (see Section 9B.11) may be used where a pushbutton detector has been installed exclusively to actuate a green phase for bicyclists.
- ⁰⁸ The R10-25 sign (see Figure 2B-26) may be used where a pushbutton detector has been installed for pedestrians to activate In-Roadway Warning Lights (see Chapter 4N) or flashing beacons that have been added to the pedestrian warning signs.

Support:

09 Section 4E.08 contains information regarding the application of the R10-32P plaque.

Section 2B.53 Traffic Signal Signs (R10-5 through R10-30)

Option:

01 To supplement traffic signal control, Traffic Signal signs R10-5 through R10-30 may be used to regulate road users.

02 Traffic Signal signs (see Figure 2B-27) may be installed at certain locations to clarify signal control. Among the legends that may be used for this purpose are LEFT ON GREEN ARROW ONLY (R10-5), STOP HERE ON RED (R10-6 or R10-6a) for observance of stop lines, DO NOT BLOCK INTERSECTION (R10-7) for avoidance of traffic obstructions, USE LANE(S) WITH GREEN ARROW (R10-8) for obedience to lane-use control signals (see Chapter 4M), LEFT TURN YIELD ON GREEN (symbolic circular green) (R10-12), and LEFT TURN YIELD ON FLASHING RED ARROW AFTER STOP (R10-27).

Guidance:

03 *If used, the LEFT ON GREEN ARROW ONLY (R10-5) sign, the LEFT TURN YIELD ON GREEN (symbolic circular green) (R10-12) sign, or the LEFT TURN YIELD ON FLASHING RED ARROW AFTER STOP (R10-27) sign should be located adjacent to the left-turn signal face.*

Option:

03A The (symbolic left turn arrow) ONLY YIELD ON GREEN (symbolic circular green) (R10-100) sign may be installed on signal mast arms at intersections with exclusive left turn lanes and protected-permissive phasing where a CIRCULAR GREEN indication is used to indicate a permissive left-turn movement (see Section 4D.14).

Standard:

03B **The (symbolic left turn arrow) ONLY YIELD ON GREEN (symbolic circular green) (R10-100) sign shall not be installed on signal mast arms where a flashing left-turn YELLOW ARROW is used to indicate a permissive left-turn movement (see Section 4D.14)**

Option:

03C The LEFT TURN YIELD ON GREEN (symbolic circular green) (R10-12) sign may be installed on signal mast arms at intersections with shared left-turn lanes and protected or permissive phasing.

03D A supplemental post-mounted LEFT TURN YIELD ON GREEN (symbolic circular green) (R10-12) sign may be installed adjacent to or above the far left signal display at intersections with protected-permissive phasing.

04 If needed for additional emphasis, an additional LEFT TURN YIELD ON GREEN (symbolic circular green) (R10-12) sign with an AT SIGNAL (R10-31P) supplemental plaque (see Figure 2B-27) may be installed in advance of the intersection.

05 In situations where traffic control signals are coordinated for progressive timing, the Traffic Signal Speed (I1-1) sign may be used (see Section 2H.03).

Standard

06 **The CROSSWALK STOP ON RED (symbolic circular red) (R10-23) sign (see Figure 2B-27) shall only be used in conjunction with pedestrian hybrid beacons (see Section 4F.02).**

07 **The EMERGENCY SIGNAL (R10-13) sign (see Figure 2B-27) shall be used in conjunction with emergency-vehicle traffic control signals (see Section 4G.02).**

08 **The EMERGENCY SIGNAL—STOP ON FLASHING RED (R10-14 or R10-14a) sign (see Figure 2B-27) shall be used in conjunction with emergency-vehicle hybrid beacons (see Section 4G.04).**

Option:

09 In order to remind drivers who are making turns to yield to pedestrians, a Turning Vehicles Yield to Pedestrians (R10-15) sign (see Figure 2B-27) may be used.

10 A U-TURN YIELD TO RIGHT TURN (R10-16) sign (see Figure 2B-27) may be installed near the left-turn signal face if U-turns are allowed on a protected left-turn movement on an approach from which a right-turn GREEN ARROW signal indication is simultaneously being displayed to drivers making a right turn from the conflicting approach to their left.

[Delete sign R10-17a from Figure 2B-27 Traffic Signal Signs and Plaques.]

Section 2B.54 No Turn on Red Signs (R10-11 Series, R10-17a, and R10-30)

Standard:

01 Where a right turn on red (or a left turn on red from a one-way street to a one-way street) is to be prohibited, a symbolic NO TURN ON RED (symbolic circular red) (R10-11) sign (see Figure 2B-27) or a NO TURN ON RED (R10-11a, R10-11b) word message sign (see Figure 2B-27) shall be used.

Guidance:

02 *If used, the No Turn on Red sign should be installed near the appropriate signal head.*

03 *A No Turn on Red sign should be considered when an engineering study finds that one or more of the following conditions exists:*

- A. Inadequate sight distance to vehicles approaching from the left (or right, if applicable);*
- B. Geometrics or operational characteristics of the intersection that might result in unexpected conflicts;*
- C. An exclusive pedestrian phase;*
- D. An unacceptable number of pedestrian conflicts with right-turn-on-red maneuvers, especially involving children, older pedestrians, or persons with disabilities;*
- E. More than three right-turn-on-red accidents reported in a 12-month period for the particular approach; or*
- F. The skew angle of the intersecting roadways creates difficulty for drivers to see traffic approaching from their left.*

Option:

04 A supplemental R10-20aP plaque (see Figure 2B-27) showing times of day (similar to the S4-1P plaque shown in Figure 7B-1) with a black legend and border on a white background may be mounted below a No Turn on Red sign to indicate that the restriction is in place only during certain times.

05 Alternatively, a blank-out sign may be used instead of a static NO TURN ON RED sign, to display either the NO TURN ON RED legend or the No Right Turn symbol or word message, as appropriate, only at certain times during the day or during one or more portion(s) of a particular cycle of the traffic signal.

06 On signalized approaches with more than one right-turn lane, a NO TURN ON RED EXCEPT FROM RIGHT LANE (R10-11c) sign (see Figure 2B-27) may be post-mounted at the intersection or a NO TURN ON RED FROM THIS LANE (with down arrow) (R10-11d) sign (see Figure 2B-27) may be mounted directly over the center of the lane from which turns on red are prohibited.

Guidance:

~~**07** *Where turns on red are permitted and the signal indication is a steady RED ARROW, the RIGHT (LEFT) ON RED ARROW AFTER STOP (R10-17a) sign (see Figure 2B-27) should be installed adjacent to the RED ARROW signal indication.*~~

Option:

08 A RIGHT TURN ON RED MUST YIELD TO U-TURN (R10-30) sign (see Figure 2B-27) may be installed to remind road users that they must yield to conflicting u-turn traffic on the street or highway onto which they are turning right on a red signal after stopping.

Section 2B.59 Weight Limit Signs (R12-1 through R12-5)

Guidance:

00A *Roadways, bridges, and other structures should be posted with signs R12-1 to R12-101 indicating the maximum safe sustainable loading to which they may be subjected if that loading is less than the maximum load allowed without a permit.*

00B *On state highways, bridge postings should be approved by the chief bridge engineer of the Alaska Department of Transportation and Public Facilities.*

Option:

01 The Weight Limit (R12-1) sign carrying the legend WEIGHT LIMIT XX TONS may be used to indicate vehicle weight restrictions including load.

02 Where the restriction applies to axle weight rather than gross load, the legend may be AXLE WEIGHT LIMIT XX TONS or AXLE WEIGHT LIMIT XX LBS (R12-2).

- 03 To restrict trucks of certain sizes by reference to empty weight in residential areas, the legend may be NO TRUCKS OVER XX TONS EMPTY WT or NO TRUCKS OVER XX LBS EMPTY WT (R12-3).
- 04 In areas where multiple regulations of the type described in Paragraphs 1 through 3 are applicable, a sign combining the necessary messages on a single sign may be used, such as WEIGHT LIMIT XX TONS PER AXLE, XX TONS GROSS (R12-4).
- 05 Posting of specific load limits may be accomplished by use of the Weight Limit symbol sign (R12-5). A sign containing the legend WEIGHT LIMIT on the top two lines, and showing three different truck symbols and their respective weight limits for which restrictions apply may be used, with the weight limits displayed to the right of each symbol as XX T. A bottom line of legend stating GROSS WT may be included if needed for enforcement purposes.

Standard:

- 06 **If used, the Weight Limit sign (see Figure 2B-29) shall be located in advance of the applicable section of highway or structure.**

Guidance:

- 07 *If used, the Weight Limit sign with an advisory distance ahead legend should be placed at approach road intersections or other points where prohibited vehicles can detour or turn around.*

Standard:

- 07A **Temporary restriction signs reading LEGAL LIMIT (variable %) OF MAX. AXLE LOAD (R12-102) shall be posted on state highways during spring breakup or at any time when roadway conditions require restriction of weights. These signs shall be posted in conspicuous locations when so ordered by the regional director of operations after suitable public notice. These signs need not be posted on all the affected routes when the restrictions apply to an area.**

Option:

- 08 An AXLE WEIGHT LIMIT 5 TONS (variable weight) (R12-2) sign may be mounted under an R12-102 sign.

Section 2B.60 Weigh Station Signs (R13 Series)

Guidance:

- 01 *An R13-1 sign with the legend TRUCKS OVER XX TONS MUST ENTER WEIGH STATION NEXT RIGHT (see Figure 2B-30) should be used to direct appropriate traffic into a weigh station.*
- 02 *The R13-1 sign should be supplemented by the D8 series of guide signs (see Section 2D.49).*

~~*Option:*~~

- ~~03 *The reverse color combination, a white legend and border on a black background, may be used for the R13-1 sign.*~~

Standard:

- 03A **The standard color of the ALL TRUCKS/COMMERCIAL/VEHICLES/NEXT RIGHT (R13-1) sign shall be a black legend and border on a white background.**

Section 2B.64 Headlight Use Signs (R16-5 through R16-11)

Support:

- 01 Some States require road users to turn on their vehicle headlights under certain weather conditions, as a safety improvement measure on roadways experiencing high crash rates, or in special situations such as when driving through a tunnel.
- 02 Figure 2B-31 shows the various signs that can be used for informing motorists of these requirements.

Option:

- 03 A LIGHTS ON WHEN USING WIPERS (R16-5) sign or a LIGHTS ON WHEN RAINING (R16-6) sign may be installed to inform road users of State laws regarding headlight use. Although these signs are typically installed facing traffic entering the State just inside the State border, they also may be installed at other locations within the State.

Guidance:

04 *If a particular section of roadway has been designated as a safety improvement zone within which headlight use is required, a TURN ON HEADLIGHTS NEXT XX MILES (R16-7) sign or a BEGIN DAYTIME HEADLIGHT SECTION (R16-10) sign should be installed at the upstream end of the section, and a END DAYTIME HEADLIGHT SECTION (R16-11) sign should be installed at the downstream end of the section.*

Option:

05 A TURN ON HEADLIGHTS (R16-8) sign may be installed to require road users to turn on their headlights in special situations such as when driving through a tunnel. A CHECK HEADLIGHTS (R16-9) sign may be installed downstream from the special situation to inform drivers that the using their headlights is no longer required.

05A The HEADLIGHTS ON AT ALL TIMES (R16-110) sign or other approved Headlight Use signs may be used to address safety concerns about head-on collisions on undivided highways, in Highway Safety Corridors at approaches to tunnels, in construction or maintenance work areas where dust impairs visibility, and at other appropriate locations. On rural roads, these signs should be placed approximately every 10 minutes of travel time.

05B The ENFORCEMENT ENDS (R16-116) sign, mounted below a HEADLIGHTS ON FOR SAFETY (I-190) sign may be used to mark the end of a HEADLIGHTS ON AT ALL TIMES zone.

Section 2B.66 Seat Belt Symbol

Standard:

01 **When a seat belt symbol is used, the symbol shown in Figure 2B-32 shall be used.**

Guidance:

02 *The seat belt symbol should not be used alone. If used, the seat belt symbol should be incorporated into regulatory sign messages for mandatory seat belt use.*

02A *The BUCKLE UP FOR SAFETY (symbol) (R16-1) sign should be used near major state entry points to inform visitors of Alaska's mandatory safety belt law, and at other points to remind and encourage motorists to use their seat belts.*

[The following are new sections. There are no corresponding sections in the MUTCD.]

Section 2B.100 STUDED TIRES PROHIBITED Sign (R5-100)

Standard:

01 **The STUDED TIRES PROHIBITED (R5-100) sign shall be installed in conspicuous locations at major entrances to an area where a law, commissioner's order (AS 28.38.155), or local ordinance prohibits the use of studded tires.**

Section 2B.101 NO STUDED TIRES MAY 1 TO SEPT 15 (APRIL 15 TO SEPT 30) Sign (R12-103)

Option:

01 The NO STUDED TIRES MAY 1 TO SEPT. 15 (APRIL 15 TO SEPT. 30) (R12-103) sign may be installed on all highways in conspicuous locations. Use "MAY 1 to SEPT. 15" north of 60°N latitude and "APRIL 15 TO SEPT. 30" south of 60°N latitude, as per AS 28.35.155.

Section 2B.102 NO ROAD MAINTENANCE AFTER (date) Sign (R11-100)

Guidance:

01 *The NO ROAD MAINTENANCE AFTER (date) (R11-100) sign should be installed at the location where year-round maintenance ends.*

Standard:

- 02 **In locations where the R11-100 signs are not permanently installed, signs shall be posted at least one month before the effective date.**

Option:

- 03 This sign may be installed on a Type III barricade in addition to being post-mounted on the right side of the roadway with the appropriate advance warning signs such as END MAINTENANCE 1000 FT. (W14-102) sign. An additional sign may be placed on the left where the roadway exceeds 40 feet in width.

Section 2B.103 \$1000 FINE FOR LITTERING Sign (R16-106)

Support:

- 01 Alaska Statutes 46.06.100, state “The penalties imposed for littering shall be posted along the public highways of the state, at visitor centers, at entrances to state parks and recreational areas, at public beaches, and other publicly owned public places the commissioner determines necessary to accomplish the purposes of this chapter. The state agency or municipality responsible for litter removal from a public place shall post the notice required by this section.”

Standard:

- 02 **The \$1000 FINE FOR LITTERING (R16-106) sign shall also be posted near the state boundary on each primary and secondary highway.**

Section 2B.104 No Shooting Signs (R16-104, R16-105)

Option:

- 01 When used, the NO SHOOTING FROM ROADWAY (R16-104) sign or NO SHOOTING WITHIN 1/4 MILE OF THE ROADWAY (R16-105) sign may be posted adjacent to the roadway where shooting is likely to occur.

Section 2B.105 Chains Required Signs (R12-104 through R12-107)

Standard:

- 01 **Signs requiring the use of chains shall not be used except where required by conditions and ordered by the commissioner. Ice or snow must be such that chains are necessary to prevent traffic congestion and accidents. Do not install the signs until the commissioner or the commissioner’s designated representative certifies by means of an order (similar to a speed zone order) that vehicles without chains are not permitted to use the roadway.**
- 02 **The CHAINS REQUIRED ON ALL VEHICLES (R12-105) sign shall be installed where chains are required before a vehicle may proceed.**
- 03 **Install an END CHAIN AREA (R12-107) sign at the end of the designated roadway section.**

Option:

- 04 The CHAINS REQUIRED AHEAD (R12-104) sign may be installed in advance of a location where chains may be installed and in advance of a road segment where chain use is required. Locate the sign at a distance in advance of the installation point as indicated in Section 2C.05, Table 2C-4, Condition B of the MUTCD and 0 mph as the speed at condition of concern. Greater distances may be advisable where ice and snow conditions on the roadway require longer stopping distances.
- 05 The INSTALL CHAINS HERE (Arrow) (R12-106) sign may be used to indicate a wide shoulder, pullout, rest area, or other parking area where a motorist may pull off the road to turn around or to install chains.

Section 2B.106 ALL VEHICLES STOP AT CUSTOMS Sign (R13-103)

Guidance:

- 01 *The ALL VEHICLES STOP AT CUSTOMS (R13-103) sign should be installed between a D8-102 and a D8-103 sign in accordance with Section 2S.06. The R13-103 sign should be in place only when the Customs Station is in operation. It should be removed or covered at all other times. It should be installed 4,000 feet in advance of the Customs Station or at the beginning of the deceleration lane, whichever distance is greater.*

CHAPTER 2C. WARNING SIGNS AND OBJECT MARKERS

Section 2C.01 Function of Warning Signs

Support:

- 01 Warning signs call attention to unexpected conditions on or adjacent to a highway, street, or private roads open to public travel and to situations that might not be readily apparent to road users. Warning signs alert road users to conditions that might call for a reduction of speed or an action in the interest of safety and efficient traffic operations.
- 01A Unexpected conditions or situations are those not readily apparent to road users primarily due to restricted sight distance. Such conditions can also include designated features, such as trail crossings, railroad–highway crossings, intersections, driveways, and vertical and horizontal curvature, which introduce conflicts between road users inconsistent with the surrounding environment and land use. Sites with unusually high crash rates are also candidates for evaluation for these conditions or situations.

Section 2C.03 Design of Warning Signs

[Delete signs W25-1 and W25-2 from Table 2C-1 Categories of Warning Signs and Plaques.]

[Delete signs W25-1 and W25-2 from Table 2C-2 Warning Sign and Plaque Sizes.]

Standard:

- 01 **Except as provided in Paragraph 2 or unless specifically designated otherwise, all warning signs shall be diamond-shaped (square with one diagonal vertical) with a black legend and border on a yellow background. Warning signs shall be designed in accordance with the sizes, shapes, colors, and legends contained in the “Standard Highway Signs and Markings” book (see Section 1A.11).**

Option:

- 02 A warning sign that is larger than the size shown in the Oversized column in Table 2C-2 for that particular sign may be diamond-shaped or may be rectangular or square in shape.
- 03 Except for symbols on warning signs, minor modifications may be made to the design provided that the essential appearance characteristics are met. Modifications may be made to the symbols shown on combined horizontal alignment/intersection signs (see Section 2C.11) and intersection warning signs (see Section 2C.46) in order to approximate the geometric configuration of the intersecting roadway(s).
- 04 Word message warning signs other than those provided in this Manual may be developed and installed by State and local highway agencies.
- 05 Warning signs regarding conditions associated with pedestrians, bicyclists, and playgrounds may have a black legend and border on a yellow or fluorescent yellow-green background only within school areas.

Standard:

- 06 **Warning signs regarding conditions associated with school buses and schools and their related supplemental plaques shall have a black legend and border on a fluorescent yellow-green background (see Section 7B.07).**

Section 2C.04 Size of Warning Signs

Standard:

- 01 **Except as provided in Section 2A.11, the sizes for warning signs shall be as shown in Table 2C-2.**

Support:

- 02 Section 2A.11 contains information regarding the applicability of the various columns in Table 2C-2.

Standard:

- 03 **Except as provided in Paragraph 5, the minimum size for all diamond-shaped warning signs facing traffic on a multi-lane conventional road where the posted speed limit is higher than 35 mph shall be 36 x 36 inches.**

04 **The minimum size for supplemental warning plaques that are not included in Table 2C-2 shall be as shown in Table 2C-3.**

Option:

05 If a diamond-shaped warning sign is placed on the left-hand side of a multi-lane roadway to supplement the installation of the same warning sign on the right-hand side of the roadway, the minimum size identified in the Single Lane column in Table 2C-2 may be used.

06 Signs and plaques larger than those shown in Tables 2C-2 and 2C-3 may be used (see Section 2A.11).

Guidance:

07 *The minimum size for all diamond-shaped warning signs facing traffic on exit and entrance ramps at major interchanges connecting an Expressway or Freeway with an Expressway or Freeway (see Section 2E.32A(a)) should be the size identified in Table 2C-2 for the mainline roadway classification (Expressway or Freeway). If a minimum size is not provided in the Freeway Column, the Expressway size should be used. If a minimum size is not provided in the Freeway or the Expressway Column, the Oversized size should be used.*

07A *The minimum size for all diamond-shaped warning signs facing traffic on exit and entrance ramps at all other interchanges (see Section 2E.32.A(b), B and C) should be 36" by 36".*

Section 2C.06 Horizontal Alignment Warning Signs

Support:

01 A variety of horizontal alignment warning signs (see Figure 2C-1), pavement markings (see Chapter 3B), and delineation (see Chapter 3F) can be used to advise motorists of a change in the roadway alignment. Uniform application of these traffic control devices with respect to the amount of change in the roadway alignment conveys a consistent message establishing driver expectancy and promoting effective roadway operations. The design and application of horizontal alignment warning signs to meet those requirements are addressed in Sections 2C.06 through 2C.15.

Standard:

02 ~~In advance of horizontal curves on freeways, on expressways, and on roadways with more than 1,000 AADT that are functionally classified as arterials or collectors, horizontal alignment warning signs shall be used in accordance with Table 2C-5 based on the speed differential between the roadway's posted or statutory speed limit or 85th-percentile speed, whichever is higher, or the prevailing speed on the approach to the curve, and the horizontal curve's advisory speed.~~

Option:

03 ~~Horizontal Alignment Warning signs may also be used on other roadways or on arterial and collector roadways with less than 1,000 AADT based on engineering judgment.~~

Table 2C-5. Horizontal Alignment Sign Selection

Type of Horizontal Alignment Sign	Difference Between Speed Limit and Advisory Speed				
	5 mph	10 mph	15 mph	20 mph	25 mph or more
Turn (W1-1), Curve (W1-2), Reverse Turn (W1-3), Reverse Curve (W1-4), Winding Road (W1-5), and Combination Horizontal Alignment/Intersection (W1-10 series) (see Section 2C.07 to determine which sign to use)	Recommended	Required	Required	Required	Required
Advisory Speed Plaque (W13-1P)	Recommended	Required	Required	Required	Required
Chevrons (W1-8) and/or One Direction Large Arrow (W1-6)	Optional	Recommended Optional	Required Recommended	Required	Required
Exit Speed (W13-2) and Ramp Speed (W13-3) on exit ramp	Optional	Optional	Recommended	Required	Required

Note: Required means that the sign and/or plaque shall be used, recommended means that the sign and/or plaque should be used, and optional means that the sign and/or plaque may be used.

See Section 2C.06 for roadways with less than 1,000 AADT.

Section 2C.08 Advisory Speed Plaque (W13-1P)

Option:

⁰¹ The Advisory Speed (W13-1P) plaque (see Figure 2C-1) may be used to supplement any warning sign to indicate the advisory speed for a condition.

Standard:

⁰² **The use of the Advisory Speed plaque for horizontal curves shall be in accordance with the information shown in Table 2C-5. The Advisory Speed plaque shall also be used where an engineering study indicates a need to advise road users of the advisory speed for other roadway conditions.**

⁰³ **If used, the Advisory Speed plaque shall carry the message XX MPH. The speed displayed shall be a multiple of 5 mph.**

⁰⁴ **Except in emergencies or when the condition is temporary, an Advisory Speed plaque shall not be installed until the advisory speed has been determined by an engineering study.**

~~⁰⁵ The Advisory Speed plaque shall only be used to supplement a warning sign and shall not be installed as a separate sign installation.~~

⁰⁶ **The advisory speed shall be determined by an engineering study that follows established engineering practices.**

^{06A} **The Advisory Speed plaque (W13-1) shall only be installed in conjunction with another appropriate warning sign to indicate the safe speed that may be used to traverse the condition indicated on the primary sign. It shall be installed on the same post directly below the primary warning sign. The speed shown shall not be in excess of the posted speed limit.**

^{06B} **The safe speed for Turn and Curve signs shall be determined by the following procedures:**

A. Existing Curves:

- 1. A mechanical or electronic Ball-Bank indicator shall be used to determine the advisory speed for curves.**
- 2. Use Ball-Bank indicator readings from trial speed runs and Table 2C-100.**

B. Curves on Design Projects:

- 1. Use Figure 2C-100.**

Table 2C-100. Safe Speed and Ball-Bank Readings

Safe Speed (MPH)	Reading (Degrees)
0-20	15.0
25-30	12.5
35-65	10.0

Support:

^{06C} It is generally preferable to determine advisory speeds by ball-banking curves after construction instead of using Figure 2C-100 during the design process.

~~⁰⁷ Among the established engineering practices that are appropriate for the determination of the recommended advisory speed for a horizontal curve are the following:~~

- ~~A. An accelerometer that provides a direct determination of side friction factors~~
- ~~B. A design speed equation~~
- ~~C. A traditional ball-bank indicator using the following criteria:~~
 - ~~1. 16 degrees of ball-bank for speeds of 20 mph or less~~
 - ~~2. 14 degrees of ball-bank for speeds of 25 to 30 mph~~
 - ~~3. 12 degrees of ball-bank for speeds of 35 mph and higher~~

~~⁰⁸ The 16, 14, and 12 degrees of ball-bank criteria are comparable to the current AASHTO horizontal curve design guidance. Research has shown that drivers often exceed existing posted advisory curve speeds by 7 to 10 mph.~~

Guidance:

^{08A} *The posted advisory speed on curves should be the closest 5-mph increment to the speed determined using either the Ball-Bank method (preferred) or Figure 2C-100.*

^{08B} *In non-curve situations, the advisory speed will depend on engineering judgment. In order to prevent driver contempt, care should be taken to avoid posting advisory speeds too low.*

⁰⁹ *The advisory speed should be determined based on free-flowing traffic conditions.*

¹⁰ *Because changes in conditions, such as roadway geometrics, surface characteristics, or sight distance, might affect the advisory speed, each location should be evaluated periodically or when conditions change.*

Standard:

10A The speed shown on the plaque shall not be in excess of the posted speed limit.

Figure 2C-100. Safe Speed on Horizontal Curves

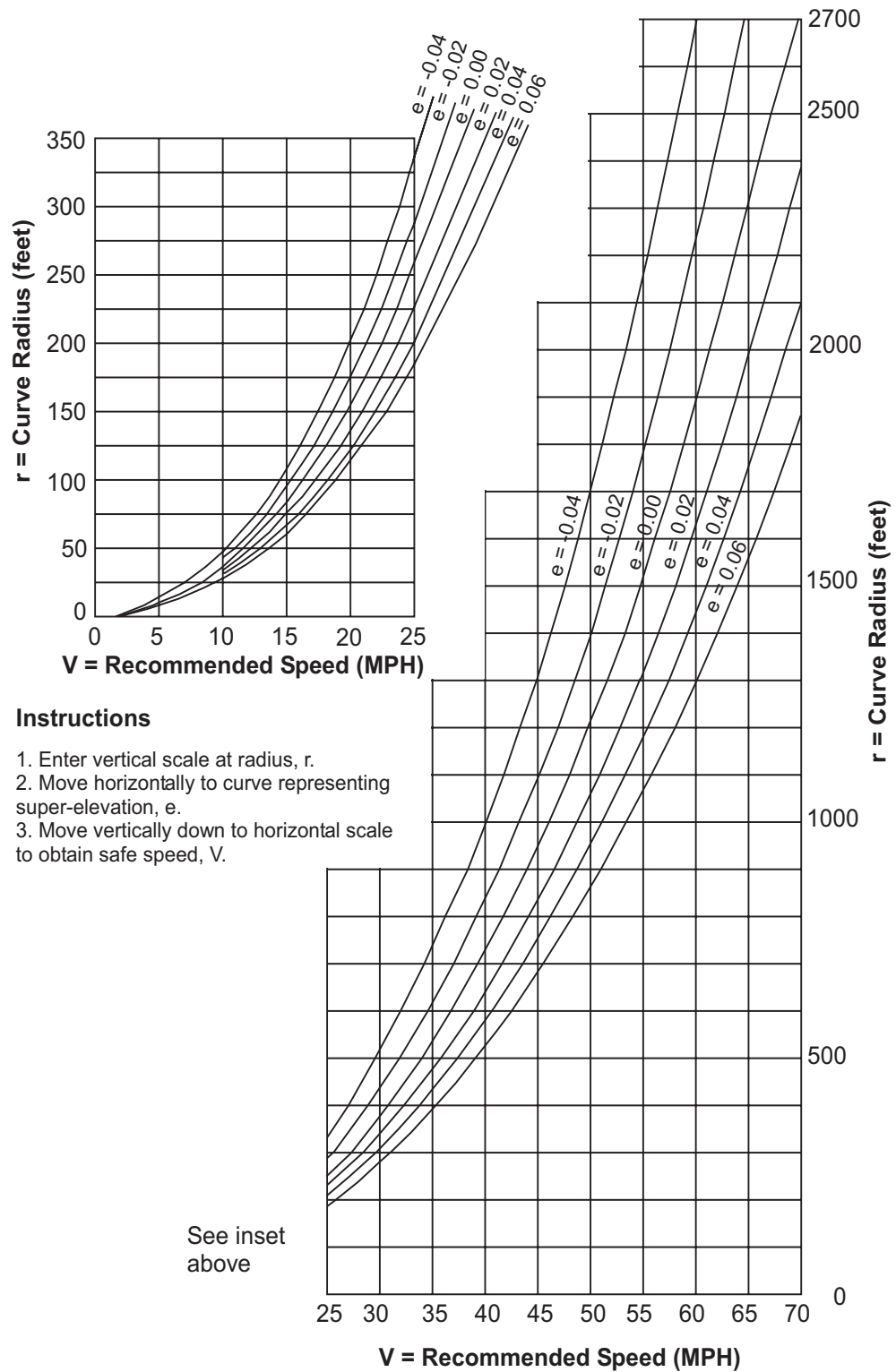

Section 2C.19 ROAD NARROWS Sign (W5-1)

Guidance:

01 *Except as provided in Paragraph 2, a ROAD NARROWS (W5-1) sign (see Figure 2C-5) should be used in advance of a transition on two-lane roads where the pavement width is reduced abruptly to a width such that vehicles traveling in opposite directions cannot simultaneously travel through the narrow portion of the roadway without reducing speed.*

Standard:

01A **The ROAD NARROWS (W5-1) sign shall not be used to indicate a change in width of shoulders. See Section 2C.31 for the SHOULDER NARROWS sign.**

Option:

02 The ROAD NARROWS (W5-1) sign may be omitted on low-volume local streets that have speed limits of 30 mph or less.

03 Additional emphasis may be provided by the use of object markers and delineators (see Sections 2B.63 through 2B.65 and Chapter 3F). The Advisory Speed (W13-1P) plaque (see Section 2C.08) may be used to indicate the recommended speed.

Section 2C.27 Low Clearance Signs (W12-2 and W12-2a)

Support:

00A LOW CLEARANCE (W12-2 or W12-2P) signs are located on and in advance of low-clearance structures and indicate the clear height from the surface of the traveled way to the lowest point of the structure directly above.

Standard:

~~01 **The Low Clearance (W12-2) sign (see Figure 2C-5) shall be used to warn road users of clearances less than 12 inches above the statutory maximum vehicle height.**~~

01A **Low Clearance signs shall be installed in accordance with Table 2C-101 .**

01B **Structure-mounted low clearance signs shall either be the W12-2A or W12-2P.**

Table 2C-101. Low Clearance Sign Requirements

Minimum Clearance	Sign on Structure (W12-2A or W12-2P)	Advance W12-2 Signs	
		At Advance Warning Distance	At 1st Upstream Intersection
17' or less	Required	-	-
16' or less	Required	Recommended	-
14'6" or less	required	Required	Recommended

Guidance:

02 *The actual clearance should be displayed on the Low Clearance sign to the nearest 1 inch not exceeding the actual clearance. However, in areas that experience changes in temperature causing frost action, a reduction, not exceeding 3 inches, should be used for this condition.*

02A *W12-2 signs to be installed at the "Advance Warning Distance" should be located at the distance in advance of the low-clearance structure indicated in Section 2C.05, Table 2C-4, Condition A of the MUTCD.*

02B *W12-2 signs to be installed at the "1st Upstream Intersection" should be located at the distance indicated in Section 2C.05, Table 2C-4, Condition B and 0 mph as the speed at condition of concern in advance of the last intersection where an alternate route may be taken. Additional signs should be installed beyond this intersection to identify the roadway with the clearance restriction.*

02C *When used, the distance indicated on the "X" MILE AHEAD (W12100) distance plate should be the mileage (to the closest ¼ mile) between the sign and the clearance restriction.*

~~03 Where the clearance is less than the legal maximum vehicle height, the W12-2 sign with a supplemental distance plaque should be placed at the nearest intersecting road or wide point in the road at which a vehicle can detour or turn around.~~

~~04 In the case of an arch or other structure under which the clearance varies greatly, two or more signs should be used as necessary on the structure itself to give information as to the clearances over the entire roadway.~~

05 Clearances should be evaluated periodically, particularly when resurfacing operations have occurred.

Option:

06 The Low Clearance sign may be installed on or in advance of the structure. If a sign is placed on the structure, it may be a rectangular shape (W12-2a) with the appropriate legend (see Figure 2C-5).

Section 2C.31 Shoulder Signs (W8-4, W8-9, W8-17, W8-23, and W8-25)

Option:

01 The SOFT SHOULDER (W8-4) sign (see Figure 2C-6) may be used to warn of a soft shoulder condition.

02 The LOW SHOULDER (W8-9) sign (see Figure 2C-6) may be used to warn of a shoulder condition where there is an elevation difference of less than 3 inches between the shoulder and the travel lane.

02A The SHOULDER NARROWS (W5-100) sign may be used to indicate a reduction in shoulder width.

Guidance:

03 *The Shoulder Drop Off (W8-17) sign (see Figure 2C-6) should be used where an unprotected shoulder drop-off, adjacent to the travel lane, exceeds 3 inches in depth for a significant continuous length along the roadway, based on engineering judgment.*

Option:

04 A SHOULDER DROP-OFF (W8-17P) supplemental plaque (see Figure 2C-6) may be mounted below the W8-17 sign.

05 The NO SHOULDER (W8-23) sign (see Figure 2C-6) may be used to warn road users that a shoulder does not exist along a portion of the roadway.

06 The SHOULDER ENDS (W8-25) sign (see Figure 2C-6) may be used to warn road users that a shoulder is ending.

Standard:

07 **When used, shoulder signs shall be placed in advance of the condition (see Table 2C-4).**

Guidance:

08 *Additional shoulder signs should be placed at appropriate intervals along the road where the condition continually exists.*

Section 2C.32 Surface Condition Signs (W8-5, W8-7, W8-8, W8-11, W8-13, and W8-14)

Option:

01 The Slippery When Wet (W8-5) sign (see Figure 2C-6) may be used to warn of unexpected slippery conditions. Supplemental plaques with legends such as ICE, WHEN WET, STEEL DECK, or EXCESS OIL may be used with the W8-5 sign to indicate the reason that the slippery conditions might be present.

02 The LOOSE GRAVEL (W8-7) sign (see Figure 2C-6) may be used to warn of loose gravel on the roadway surface.

03 The ROUGH ROAD (W8-8) sign (see Figure 2C-6) may be used to warn of a rough roadway surface.

04 An UNEVEN LANES (W8-11) sign (see Figure 2C-6) may be used to warn of a difference in elevation between travel lanes.

~~05 The BRIDGE ICES BEFORE ROAD (W8-13) sign (see Figure 2C-6) may be used in advance of bridges to advise bridge users of winter weather conditions. The BRIDGE ICES BEFORE ROAD sign may be removed or covered during seasons of the year when its message is not relevant.~~

06 The FALLEN ROCKS (W8-14) sign (see Figure 2C-6) may be used in advance of an area that is adjacent to a hillside, mountain, or cliff where rocks frequently fall onto the roadway.

06A The BRIDGE ICES BEFORE ROAD (W8-13) sign (see Figure 2C-6) may be used in advance of bridges to advise bridge users of winter weather conditions.

Guidance:

06B The BRIDGE ICES BEFORE ROAD sign (see Figure 2C-6) and BRIDGES MAY BE ICY (W8-113) signs should be covered during seasons of the year when its message is not relevant.

07 When used, Surface Condition signs should be placed in advance of the beginning of the affected section (see Table 2C-4), and additional signs should be placed at appropriate intervals along the road where the condition exists.

Section 2C.36 Advance Traffic Control Signs (W3-1, W3-2, W3-3, W3-4)

Standard:

01 The Advance Traffic Control symbol signs (see Figure 2C-6) include the Stop Ahead (W3-1), Yield Ahead (W3-2), and Signal Ahead (W3-3) signs. These signs shall be installed on an approach to a primary traffic control device that is not visible for a sufficient distance to permit the road user to respond to the device (see Table 2C-4). The visibility criteria for a traffic control signal shall be based on having a continuous view of at least two signal faces for the distance specified in Table 4D-2.

Support:

02 Figure 2A-4 shows the typical placement of an Advance Traffic Control sign.

03 Permanent obstructions causing the limited visibility might include roadway alignment or structures. Intermittent obstructions might include foliage or parked vehicles.

Guidance:

04 Where intermittent obstructions occur, engineering judgment should determine the treatment to be implemented.

Option:

05 An Advance Traffic Control sign may be used for additional emphasis of the primary traffic control device, even when the visibility distance to the device is satisfactory.

06 An advance street name plaque (see Section 2C.58) may be installed above or below an Advance Traffic Control sign.

07 A warning beacon may be used with an Advance Traffic Control sign.

08 A BE PREPARED TO STOP (W3-4) sign (see Figure 2C-6) may be used to warn of stopped traffic caused by a traffic control signal or in advance of a section of roadway that regularly experiences traffic congestion.

Standard:

09 When a BE PREPARED TO STOP sign is used in advance of a traffic control signal, it shall be used in addition to a Signal Ahead sign and shall be placed downstream from the Signal Ahead (W3-3) sign.

Option:

10 The BE PREPARED TO STOP sign may be supplemented with a warning beacon (see Section 4L.03).

Guidance:

11 When the warning beacon is interconnected with a traffic control signal or queue detection system, the BE PREPARED TO STOP sign should be supplemented with a WHEN FLASHING (W16-13P) plaque (see Figure 2C-12).

Support:

12 Section 2C.40 contains information regarding the use of a NO MERGE AREA (W4-5P) supplemental plaque in conjunction with a Yield Ahead sign.

12A See Chapter 4Z. Active Advance Warning Flashers.

Section 2C.40 Merge Signs (W4-1, W4-5)

Option:

- 01 A Merge (W4-1) sign (see Figure 2C-8) may be used to warn road users on the major roadway that merging movements might be encountered in advance of a point where lanes from two separate roadways converge as a single traffic lane and no turning conflict occurs.
- 02 A Merge sign may also be installed on the side of the entering roadway to warn road users on the entering roadway of the merge condition.

Guidance:

- 03 *The Merge sign should be installed on the side of the major roadway where merging traffic will be encountered and in such a position as to not obstruct the road user's view of entering traffic.*
- 04 *Where two roadways of approximately equal importance converge, a Merge sign should be placed on each roadway.*
- 05 *When a Merge sign is to be installed on an entering roadway that curves before merging with the major roadway, such as a ramp with a curving horizontal alignment as it approaches the major roadway, the Entering Roadway Merge (W4-5) sign (see Figure 2C-8) should be used to better portray the actual geometric conditions to road users on the entering roadway.*
- 06 *The Merge sign should not be used where two roadways converge and merging movements are not required.*
- 07 *The Merge sign should not be used in place of a Lane Ends sign (see Section 2C.42) where lanes of traffic moving on a single roadway must merge because of a reduction in the actual or usable pavement width.*
- 07A *When installed at merging entrance ramps, the W4-1 sign should be installed 100 feet in advance of the beginning of the paved gore preceding the merge. If there is insufficient width at this point to install the sign with appropriate clearance from pavement edges, it should be moved further upstream until the desired width is obtained.*

Option:

- 08 An Entering Roadway Merge (W4-5) sign with a NO MERGE AREA (W4-5P) supplemental plaque (see Figure 2C-8) mounted below it may be used to warn road users on an entering roadway that they will encounter an abrupt merging situation without an acceleration lane at the downstream end of the ramp.
- 09 A Merge (W4-1) sign with a NO MERGE AREA (W4-5P) supplemental plaque mounted below it may be used to warn road users on the major roadway that traffic on an entering roadway will encounter an abrupt merging situation without an acceleration lane at the downstream end of the ramp.
- 10 For a yield-controlled channelized right-turn movement onto a roadway without an acceleration lane, a NO MERGE AREA (W4-5P) supplemental plaque may be mounted below a Yield Ahead (W3-2) sign and/or below a YIELD (R1-2) sign when engineering judgment indicates that road users would expect an acceleration lane to be present.

Section 2C.41 Added Lane Signs (W4-3, W4-6)

Guidance:

- 01 *The Added Lane (W4-3) sign (see Figure 2C-8) should be installed in advance of a point where two roadways converge and merging movements are not required. When possible, the Added Lane sign should be placed such that it is visible from both roadways; if this is not possible, an Added Lane sign should be placed on the side of each roadway.*
- 01A *When installed at added-lane entrance ramps, the W4-3 sign should be installed 100 feet in advance of the beginning of the paved gore preceding the lane-add. If there is insufficient width at this point to install the sign with appropriate clearance from pavement edges, it should be moved further upstream until the desired width is obtained.*
- 02 *When an Added Lane sign is to be installed on a roadway that curves before converging with another roadway that has a tangent alignment at the point of convergence, the Entering Roadway Added Lane (W4-6) sign (see Figure 2C-8) should be used to better portray the actual geometric conditions to road users on the curving roadway.*

[Delete the TRAFFIC CIRCLE (W16-12p) sign in Figure 2C-9, Intersection Warning Signs]

Section 2C.46 Intersection Warning Signs (W2-1 through W2-8)

Option:

- 01 A Cross Road (W2-1) symbol, Side Road (W2-2 or W2-3) symbol, T-Symbol (W2-4), or Y-Symbol (W2-5) sign (see Figure 2C-9) may be used in advance of an intersection to indicate the presence of an intersection and the possibility of turning or entering traffic.
- 02 The Circular Intersection (W2-6) symbol sign (see Figure 2C-9) may be installed in advance of a circular intersection (see Figures 2B-21 through 2B-23).

Guidance:

- 03 *If an approach to a roundabout has a statutory or posted speed limit of 40 mph or higher, the Circular Intersection (W2-6) symbol sign should be installed in advance of the circular intersection.*

Option:

- 04 An educational plaque (see Figure 2C-9) with a legend such as ROUNDABOUT (W16-17P) ~~or TRAFFIC CIRCLE (W16-12P)~~ may be mounted below a Circular Intersection symbol sign.
- 05 The relative importance of the intersecting roadways may be shown by different widths of lines in the symbol.
- 06 An advance street name plaque (see Section 2C.58) may be installed above or below an Intersection Warning sign.

Guidance:

- 07 *The Intersection Warning sign should illustrate and depict the general configuration of the intersecting roadway, such as cross road, side road, T-intersection, or Y-intersection.*
- 08 *Intersection Warning signs, other than the Circular Intersection (W2-6) symbol sign and the T-intersection (W2-4) symbol sign should not be used on approaches controlled by STOP signs, YIELD signs, or signals.*
- 09 *If an Intersection Warning sign is used where the side roads are not opposite of each other, the Offset Side Roads (W2-7) symbol sign (see Figure 2C-9) should be used instead of the Cross Road symbol sign.*
- 10 *If an Intersection Warning sign is used where two closely-spaced side roads are on the same side of the highway, the Double Side Roads (W2-8) symbol sign (see Figure 2C-9) should be used instead of the Side Road symbol sign.*
- 11 *No more than two side road symbols should be displayed on the same side of the highway on a W2-7 or W2-8 symbol sign, and no more than three side road symbols should be displayed on a W2-7 or W2-8 symbol sign.*

Support:

- 12 Figure 2A-4 shows the typical placement of an Intersection Warning sign.

Section 2C.48 Traffic Signal Signs (W25-1, W25-2)

[Delete signs W25-1 and W25-2 from Figure 2C-9 Intersection Warning Signs and Plaques.]

Standard:

- 01 ~~At locations where either a W25-1 or a W25-2 sign is required based on the provisions in Section 4D.05, the W25-1 or W25-2 sign (see Figure 2C-9) shall be installed near the left-most signal head. The W25-1 and W25-2 signs shall be vertical rectangles. The W25-1 and W25-2 signs shall not be used in Alaska.~~

Section 2C.49 Vehicular Traffic Warning Signs (W8-6, W11-1, W11-5, W11-5a, W11-8, W11-10, W11-11, W11-12P, W11-14, W11-15, and W11-15a)

Option:

- 01 Vehicular Traffic Warning (W8-6, W11-1, W11-5, W11-5a, W11-8, W11-10, W11-11, W11-12P, W11-14, W11-15, and W11-15a) signs (see Figure 2C-10) may be used to alert road users to locations where unexpected entries into the roadway by trucks, bicyclists, farm vehicles, emergency vehicles, golf carts, horse-drawn vehicles, or other vehicles might occur. The TRUCK CROSSING (W8-6) word message sign may be used as an alternate to the Truck Crossing (W11-10) symbol sign.

Support:

02 These locations might be relatively confined or might occur randomly over a segment of roadway.

Guidance:

03 *Vehicular Traffic Warning signs should be used only at locations where the road user's sight distance is restricted, or the condition, activity, or entering traffic would be unexpected.*

04 *If the condition or activity is seasonal or temporary, the Vehicular Traffic Warning sign should be removed or covered when the condition or activity does not exist.*

Option:

05 The combined Bicycle/Pedestrian (W11-15) sign may be used where both bicyclists and pedestrians might be crossing the roadway, such as at an intersection with a shared-use path. A TRAIL X-ING (W11-15P) supplemental plaque (see Figure 2C-10) may be mounted below the W11-15 sign. The TRAIL CROSSING (W11-15a) sign may be used to warn of shared-use path crossings where pedestrians, bicyclists, and other user groups might be crossing the roadway.

06 The W11-1, W11-15, and W11-15a signs and their related supplemental plaques may have a fluorescent yellow-green background with a black legend and border only within designated school zones.

07 Supplemental plaques (see Section 2C.53) with legends such as AHEAD, XX FEET, NEXT XX MILES, or SHARE THE ROAD may be mounted below Vehicular Traffic Warning signs to provide advance notice to road users of unexpected entries.

Guidance:

08 *If used in advance of a pedestrian and bicycle crossing, a W11-15 or W11-15a sign should be supplemented with an AHEAD or XX FEET plaque to inform road users that they are approaching a point where crossing activity might occur.*

Standard:

09 **If a post-mounted W11-1, W11-11, W11-15, or W11-15a sign is placed at the location of the crossing point where golf carts, pedestrians, bicyclists, or other shared-use path users might be crossing the roadway, a diagonal downward pointing arrow (W16-7P) plaque (see Figure 2C-12) shall be mounted below the sign. If the W11-1, W11-11, W11-15, or W11-15a sign is mounted overhead, the W16-7P supplemental plaque shall not be used.**

Option:

10 The crossing location identified by a W11-1, W11-11, W11-15, or W11-15a sign may be defined with crosswalk markings (see Section 3B.18).

Standard:

11 **The Emergency Vehicle (W11-8) sign (see Figure 2C-10) with the EMERGENCY SIGNAL AHEAD (W11-12P) supplemental plaque (see Figure 2C-10) shall be placed in advance of all emergency-vehicle traffic control signals (see Chapter 4G).**

Option:

12 The Emergency Vehicle (W11-8) sign, or a word message sign indicating the type of emergency vehicle (such as rescue squad), may be used in advance of the emergency-vehicle station when no emergency-vehicle traffic control signal is present.

13 A Warning Beacon (see Section 4L.03) may be used with any Vehicular Traffic Warning sign to indicate specific periods when the condition or activity is present or is likely to be present, or to provide enhanced sign conspicuity.

14 A supplemental WHEN FLASHING (W16-13P) plaque (see Figure 2C-12) may be used with any Vehicular Traffic Warning sign that is supplemented with a Warning Beacon to indicate specific periods when the condition or activity is present or is likely to be present.

Section 2C.50 Non-Vehicular Warning Signs (W11-2, W11-3, W11-4, W11-6, W11-7, W11-9, and W11-16 through W11-22)

Option:

⁰¹ Non-Vehicular Warning (W11-2, W11-3, W11-4, W11-6, W11-7, W11-9, and W11-16 through W11-22) signs (see Figure 2C-11) may be used to alert road users in advance of locations where unexpected entries into the roadway might occur or where shared use of the roadway by pedestrians, animals, or equestrians might occur.

Support:

⁰² These conflicts might be relatively confined, or might occur randomly over a segment of roadway.

Guidance:

⁰³ *If used in advance of a pedestrian, snowmobile, or equestrian crossing, the W11-2, W11-6, W11-7, and W11-9 signs should be supplemented with plaques (see Section 2C.55) with the legend AHEAD or XX FEET to inform road users that they are approaching a point where crossing activity might occur.*

Standard:

⁰⁴ **If a post-mounted W11-2, W11-6, W11-7, or W11-9 sign is placed at the location of the crossing point where pedestrians, snowmobilers, or equestrians might be crossing the roadway, a diagonal downward pointing arrow (W16-7P) plaque (see Figure 2C-12) shall be mounted below the sign. If the W11-2, W11-6, W11-7, or W11-9 sign is mounted overhead, the W16-7P plaque shall not be used.**

Option:

⁰⁵ A Pedestrian Crossing (W11-2) sign may be placed overhead or may be post-mounted with a diagonal downward pointing arrow (W16-7P) plaque at the crosswalk location where Yield Here To (Stop Here For) Pedestrians signs (see Section 2B.11) have been installed in advance of the crosswalk.

Standard:

⁰⁶ **If a W11-2 sign has been post-mounted at the crosswalk location where a Yield Here To (Stop Here For) Pedestrians sign is used on the approach, the Yield Here To (Stop Here For) Pedestrians sign shall not be placed on the same post as or block the road user's view of the W11-2 sign.**

Option:

⁰⁷ An advance Pedestrian Crossing (W11-2) sign with an AHEAD or a distance supplemental plaque may be used in conjunction with a Yield Here To (Stop Here For) Pedestrians sign on the approach to the same crosswalk.

⁰⁸ The crossing location identified by a W11-2, W11-6, W11-7, or W11-9 sign may be defined with crosswalk markings (see Section 3B.18).

⁰⁹ The W11-2 and W11-9 signs and their related supplemental plaques may have a fluorescent yellow-green background with a black legend and border only within designated school zones.

Guidance:

¹⁰ *When a fluorescent yellow-green background is used, a systematic approach featuring one background color within a zone or area should be used. The mixing of standard yellow and fluorescent yellow-green backgrounds within a selected site area should be avoided.*

Option:

¹¹ A Warning Beacon (see Section 4L.03) may be used with any Non-Vehicular Warning sign to indicate specific periods when the condition or activity is present or is likely to be present, or to provide enhanced sign conspicuity.

¹² A supplemental WHEN FLASHING (W16-13P) plaque (see Figure 2C-12) may be used with any Non-Vehicular Warning sign that is supplemented with a Warning Beacon to indicate specific periods when the condition or activity is present or is likely to be present.

Section 2C.51 Playground Sign (W15-1)

Option:

⁰¹ The Playground (W15-1) sign (see Figure 2C-11) may be used to give advance warning of a designated children's playground that is located adjacent to the road.

- 02 The Playground sign may have a fluorescent yellow-green background with a black legend and border only within designated school zones.

Guidance:

- 03 *If the access to the playground area requires a roadway crossing, the application of crosswalk pavement markings (see Section 3B.18) and Non-Vehicular Warning signs (see Section 2C.50) should be considered.*

Section 2C.55 Distance Plaques (W16-2 Series, W16-3 Series, W16-4P, W7-3aP)

Option:

- 01 The Distance Ahead (W16-2 series and W16-3 series) plaques (see Figure 2C-12) may be used to inform the road user of the distance to the condition indicated by the warning sign.
- 02 The Next Distance (W7-3aP and W16-4P) plaques (see Figures 2C-4 and 2C-12) may be used to inform road users of the length of roadway over which the condition indicated by the warning sign exists.

Standard:

- 02A **The Advisory Distance Plaque, NEXT “X” MILES (W7-3a) sign shall only be installed in conjunction with warning signs where conditions are similar throughout the indicated roadway section. This sign is not a substitute for signs warning of any abrupt change of the roadway character.**
- 02B **When used, advisory distance plaques shall be installed on the same post directly below the primary warning sign.**

Section 2C.64 Object Markers for Obstructions Within the Roadway

Standard:

- 01 **Obstructions within the roadway shall be marked with a Type 1 or Type 3 object marker. In addition to markers on the face of the obstruction, warning of approach to the obstruction shall be given by appropriate pavement markings (see Section 3B.10).**

Guidance:

- 01A *Type 1 Object Markers (OM-1) should be mounted directly below each R4-7 sign on the lead end of a median.*

Option:

- 02 To provide additional emphasis, a Type 1 or Type 3 object marker may be installed at or near the approach end of a median island.
- 03 To provide additional emphasis, large surfaces such as bridge piers may be painted with diagonal stripes, 12 inches or greater in width, similar in design to the Type 3 object marker.
- 03A Type 1 Object Markers (OM-1) may be mounted directly below W1-6 and W1-7 Large Arrow signs and W12-1 Double Arrow signs.
- 03B Where the median is less than 5 feet wide, a Type 2 or multiple, stacked Type 2 object markers may be installed.

Standard:

- 04 **The alternating black and retroreflective yellow stripes (OM3-L, OM3-R) shall be sloped down at an angle of 45 degrees toward the side on which traffic is to pass the obstruction. If traffic can pass to either side of the obstruction, the alternating black and retroreflective yellow stripes (OM3-C) shall form chevrons that point upwards.**

Option:

- 05 Appropriate signs (see Sections 2B.32 and 2C.25) directing traffic to one or both sides of the obstruction may be used instead of the object marker.

Section 2C.65 Object Markers for Obstructions Adjacent to the Roadway

Support:

- 01 Obstructions not actually within the roadway are sometimes so close to the edge of the road that they need a marker. These include underpass piers, bridge abutments, handrails, ends of traffic barriers, utility poles, and

culvert headwalls. In other cases there might not be a physical object involved, but other roadside conditions exist, such as narrow shoulders, drop-offs, gores, small islands, and abrupt changes in the roadway alignment, that might make it undesirable for a road user to leave the roadway, and therefore would create a need for a marker.

Standard:

- 02 **If a Type 2 or Type 3 object marker is used to mark an obstruction adjacent to the roadway, the edge of the object marker that is closest to the road user shall be installed in line with the closest edge of the obstruction.**
- 03 **Where Type 3 object markers are applied to the approach ends of guardrail and other roadside appurtenances, sheeting without a substrate shall be directly affixed to the approach end of the guardrail in a rectangular shape conforming to the size of the approach end of the guardrail with alternating black and retroreflective yellow stripes sloping downward at a angle of 45 degrees toward the side of the obstruction on which traffic is to pass.**
- 04 **Type 1 and Type 4 object markers shall not be used to mark obstructions adjacent to the roadway.**

Guidance:

- 05 *Standard warning signs in this Chapter should also be used where applicable.*
- 05A *Type 3 Object markers (OM-3) should be installed at bridges when any of the following conditions exist:*
 - A. Total road width (shoulders plus traveled way) on the bridge is narrower than the total road width of the approaching roadway.
 - B. Total two-way road width is less than 18 feet.
 - C. No guardrail is attached to the bridge end (this is not meant to imply that object markers are an adequate substitute for crashworthy treatment of bridge ends).
- 05B *When used, object markers should be installed on a separate post adjacent to the nearest guardrail post to bridge abutments when there is an approach guardrail. When there is no approach guardrail, they should be mounted on the end of the bridge rail or on a separate post.*

[The following are new sections. There are no corresponding sections in the MUTCD.]

Section 2C.100 One Lane Opposing Two Lane Sign (W6-100)

Option:

- 01 **The One Lane Opposing Two Lane (W6-100) sign may be used on two-way roadways that have no median or divider but have two through lanes in one direction and one lane in the other direction.**

Guidance:

- 02 *If used, One Lane Opposing Two Lane (W6-100) signs should be posted near the beginning of the condition.*

Option:

- 03 **The One Lane Opposing Two Lane (W6-100) signs may be posted at intermediate points within the segment that has two through lanes in one direction and one lane in the other.**

Section 2C.101 LOAD LIMIT WARNING Sign (W12-101)

Standard:

- 01 **The LOAD LIMIT WARNING (W12-101) sign shall be used to indicate the presence of a bridge with a restricted load-carrying capacity as determined by an engineering investigation. Use only in conjunction with a W12-100 distance accessory plate indicating the distance from the sign to the condition of concern. The W12-101 sign shall be installed as indicated in Section 2C.05, Table 2C-4, Condition A of the MUTCD in advance of an intersection where a driver may make a decision to take an alternate route or where a large tractor/semi trailer can turn off the highway. WEIGHT LIMIT (R12 Series) signs shall be installed at the bridge before this sign is installed.**

Section 2C.102 End Signs (W14-100, W14-101, and W14-102)

Support:

01 The END (W14-100) sign is used in the head-on position at the end of a public road.

Standard:

02 **The END-OF-ROAD (OM-4) marker shall be mounted below the W14-100 sign.**

03 **The END ROAD 1000 FT (W14-101) sign shall be installed approximately 1,000 feet in advance of the END (W14-100) sign. In special situations where the distance is substantially less than 1000 feet, the distance on the sign shall be modified accordingly.**

04 **The END MAINTENANCE 1500 FT (variable distance) (W14-102) sign shall be installed in conjunction with the NO ROAD MAINTENANCE (R11-100) sign or STATE MAINTENANCE ENDS (I-181) sign to warn of the approach of a road section that will not be maintained. Install 500 to 1500 feet in advance of the R11-100 sign with the appropriate distance in the legend.**

Option:

05 A second W14-101 sign with the appropriate distance may be installed between the initial W14-101 sign and the W14-100 sign when additional emphasis is needed.

Section 2C.103 Slide Area Signs (W16-100 and W16-101)

Support:

01 A slide area is defined as any section of roadway where rocks, snow (avalanches), or other natural debris may be expected to encroach on the roadway and create a condition that requires caution on the part of the motorist.

Guidance:

02 *The SLIDE AREA (W16-100) sign should be installed an appropriate distance in advance of the beginning of a known slide area using Section 2C.05, Table 2C-4, Condition B of the MUTCD and 0 mph as the speed at condition of concern. The END SLIDE AREA (W16-101) sign should be installed on the right in the vicinity of the end of a slide area only where W16-100 signs have been installed at the beginning of the slide area. The SLIDE series signs should be removed or covered if the slide condition ceases to exist.*

Section 2C.104 WATCH FOR ICE Sign (W16-102)

Option:

01 The WATCH FOR ICE (W16-102) sign may be used to alert a motorist driving on ice-free pavement of an isolated condition that is not readily apparent. The sign is not intended to define a general, overall road condition. See also Section 2C. 32 of the MUTCD.

Section 2C.105 WATER OVER ROADWAY Sign (W16-103)

Standard:

01 **When used, the WATER OVER ROADWAY (W16-103) sign shall be installed an appropriate distance in advance of the flooded section of roadway using Section 2C.05, Table 2C-4, of the MUTCD with Condition B and 0 mph as the speed at condition of concern.**

Option:

02 The sign may be used to warn of temporary flooding or a low spot where the roadway is normally under water.

Standard:

03 **When used to warn of temporary flooding, the signs shall be covered or removed when flooding ceases for more than 48 hours.**

Section 2C.106 Avalanche Area Signs (W16-110 through W16-112)

Support:

01 An avalanche area is defined as any section of road where major snow slides (avalanches) may be expected to encroach on the roadway.

Standard:

02 The AVALANCHE AREA (W16-110) sign shall be installed an appropriate distance in advance of the avalanche area, using Section 2C.05, Table 2C-4, Condition B of the MUTCD and 0 mph as the speed at condition of concern. The W16-110 sign shall always be followed by an END AVALANCHE AREA (W16-111) sign. The signs shall be removed or covered after the avalanche danger has abated.

Option:

03 The AVALANCHE AREA NEXT X MILES DO NOT STOP (W6-112) sign may be used for additional emphasis.

Section 2C.107 WIND AREA Sign (W16-104)

Guidance:

01 WIND AREA (W16-104) sign should be used to indicate locations where winds regularly reach velocities that substantially affect the driving task. The signs should be removed or covered during those seasons of the year when high winds are unlikely.

Section 2C.108 ROCKS (W16-105) and Rocks Symbol (W16-116) Signs

Option:

01 The ROCKS (W16-105) or Rocks symbol (W16-116) signs may be installed in advance of rock cut areas where falling rocks or rocks on the road may be encountered by motorists.

Section 2C.109 END FREEWAY ½ MILE Sign (W16-107)

Option:

01 The END FREEWAY ½ MILE (W16-107) sign may be used to indicate the end of a multilane divided roadway facility with full access control and no at-grade intersections. Install it on the right and left approximately one-half mile in advance of the first access where through traffic may encounter cross-traffic and a definite change in the facility is obvious (entering two-lane facility or city street section).

Guidance:

02 If used, the sign should not ordinarily be used at transitions from freeways to expressways (multilane divided roadway with access control and at-grade intersections).

Section 2C.110 ROAD CLOSED AHEAD (W14-103) and BRIDGE CLOSED AHEAD (W14-104) Signs

Standard:

01 The ROAD CLOSED AHEAD (W14-103) and Bridge Closed Ahead (W14-104) signs shall be installed using Section 2C.05, Table 2C-4, Condition B of the MUTCD and 0 mph as the speed at condition of concern, in advance of an intersection where a driver may take an alternate route. The Advisory Distance Plate (W12-100) shall be used in conjunction with the W14-103 or W14-104 signs.

Guidance:

02 Additional signs should be installed beyond this intersection to identify the roadway with the closure.

Section 2C.111 LOW FLYING AIRCRAFT Sign (W16-114)

Option:

- 01 The LOW FLYING AIRCRAFT (W16-114) sign may be used in those areas where low-flying aircraft are encountered, such as roadways near the end of an airfield.

Section 2C.112 AIRCRAFT CROSSING Sign (W16-106)

Guidance:

- 01 *The AIRCRAFT CROSSING (W16-106) sign should be used in those areas where taxiing aircraft cross roadways.*

Section 2C.113 JET BLAST AREA Signs (W16-108 and W16-109)

Guidance:

- 01 *The JET BLAST AREA (W16-108) sign should be used in advance of a section of roadway, which is subject to high winds and the possibility of flying debris from aircraft exhausts. Use Section 2C.05, Table 2C-4, of the MUTCD and Condition B and 0 MPH as the speed at the condition of concern. This sign should be used in conjunction with NO STOPPING OR STANDING (R7S-) signs posted from boundary to boundary of the jet blast area.*

Option:

- 02 The END JET BLAST AREA (W16-109) sign may be used where the limits of exposure are not immediately obvious.

Section 2C.114 SLOW MOVING VEHICLES Sign (W7-100)

Option:

- 01 The SLOW MOVING VEHICLES (W7-100) sign may be used on roadways where vehicles moving substantially slower than the established speed limit are common.

Section 2C.115 TRAVEL BEYOND THIS POINT NOT RECOMMENDED . . . Sign (W14-105)

Option:

- 01 The TRAVEL BEYOND THIS POINT NOT RECOMMENDED . . . (W14-105) sign may be used at the point of closure during winter road closures.

Guidance:

- 02 *This sign should not be used alone. It should be used as a supplement to other signs notifying motorists that the road is not maintained beyond that point.*

Section 2C.116 HIDDEN DRIVEWAY Sign (W7-102)

Option:

- 01 A HIDDEN DRIVEWAY (W7-102) sign may be used in advance of a driveway when sight distance is restricted by a hill or roadside sight obstruction.
- 02 A HIDDEN DRIVEWAY sign may be supplemented by an Advisory Speed (W131) plaque indicating the recommended speed based on available sight distance. It may also be supplemented with AHEAD (W16-9P), 500 FT (W16-2P), or NEXT XX MILES (W13-1A) plaques.
- 03 HIDDEN DRIVEWAY signs may be installed when available sight distance, measured in accordance with Figure 2C-101, Sight Distance Measurement for HIDDEN DRIVEWAY signs, is less than or equal to the values given in Table 2C-102, Minimum Sight Distance for HIDDEN DRIVEWAY signs.

Guidance:

- 04 *HIDDEN DRIVEWAY signs should not be used on residential or low-volume streets where the majority of the traffic is local to the area and driveways are expected.*
- 05 *Every effort should be made to obtain minimum sight distance before installing these signs.*

Table 2C-102. Minimum Sight Distance for HIDDEN DRIVEWAY Signs

Speed (mph)	Minimum Sight Distance (feet)
25	155
30	200
35	250
40	305
45	360
50	425
55	495
60	570

Source: 2004 AASHTO "Green Book" Stopping Sight Distance

Figure 2C-101. Sight Distance Measurement for HIDDEN DRIVEWAY Signs

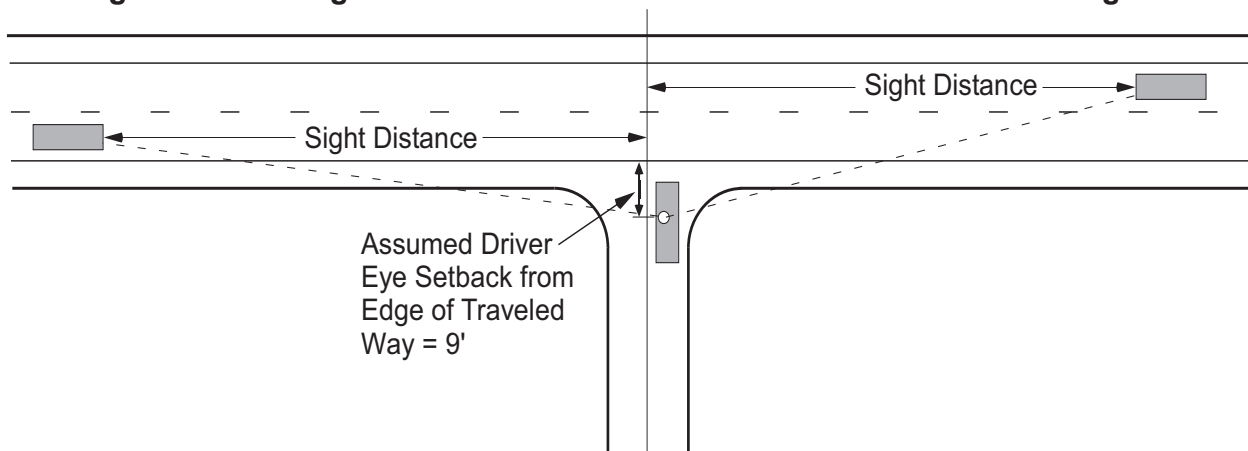

Section 2C.117 THRU TRAFFIC MERGE LEFT (RIGHT) Sign (W4-100)

Option:

- 01 The THRU TRAFFIC MERGE LEFT (RIGHT) sign (W4-100) may be used to inform motorists that the outside or inside lane is being dropped at the next exit, and through traffic must merge into the adjacent lane. It may also be used to help through traffic avoid congestion at on-ramp entrances or other choke points.

Guidance:

- 02 *The W4-100 sign should not be used to warn of lane reductions.*

Section 2C.118 DOG TEAM CROSSING Sign (W11-108)

Option:

- 01 This sign may be used, at a trail crossing location, where dog teams cross regularly.

Guidance:

- 02 *If used, the DOG TEAM CROSSING sign should be installed in advance of the trail crossing using Section 2C.05, Table 2C-4, Condition B of the MUTCD and 0 mph as the speed at the condition of concern.*

CHAPTER 2D. GUIDE SIGNS—CONVENTIONAL ROADS

Section 2D.06 Size of Lettering

Support:

- 01 Sign legibility is a direct function of letter size and spacing. Legibility distance has to be sufficient to give road users enough time to read and comprehend the sign. Under optimum conditions, a guide sign message can be read and understood in a brief glance. The legibility distance takes into account factors such as inattention, blocking of view by other vehicles, unfavorable weather, inferior eyesight, or other causes for delayed or slow reading. Where conditions permit, repetition of guide information on successive signs gives the road user more than one opportunity to obtain the information needed.

Standard:

- 02 **Design layouts for conventional road guide signs showing interline spacing, edge spacing, and other specification details shall be as shown in the “Standard Highway Signs and Markings” book (see Section 1A.11).**
- 03 **The principal legend on guide signs shall be in letters and numerals at least 6 inches in height for all upper-case letters, or a combination of 6 inches in height for upper-case letters and 4.5 inches in height for lower-case letters. ~~On low-volume roads (as defined in Section 5A.01) with speeds of 25 mph or less, and on urban streets with speeds of 25 mph or less~~ On roads with speeds of 25 mph or less or at a stop condition, the principal legend shall be in letters at least 4 inches in height for all upper-case letters, or a combination of 4 inches in height for upper-case letters and 3 inches in height for lower-case letters.**

Guidance:

- 04 *Lettering sizes should be consistent on any particular class of highway.*
- 05 *The minimum lettering sizes provided in this Manual should be exceeded where conditions indicate a need for greater legibility.*

Section 2D.09 Numbered Highway Systems

Support:

- 01 The purpose of numbering and signing highway systems is to identify routes and facilitate travel.
- 02 The Interstate and United States (U.S.) highway systems are numbered by the American Association of State Highway and Transportation Officials (AASHTO) upon recommendations of the State highway organizations because the respective States own these systems. State and county road systems are numbered by the appropriate authorities.
- 03 The basic policy for numbering the Interstate and U.S. highway systems is contained in the following Purpose and Policy statements published by AASHTO (see Page i for AASHTO’s address):
- A. “Establishment and Development of United States Numbered Highways,” and
 - B. “Establishment of a Marking System of the Routes Comprising the National System of Interstate and Defense Highways.”

Guidance:

- 04 *The principles of these policies should be followed in establishing the highway systems described in Paragraph 2 and any other systems, with effective coordination between adjacent jurisdictions. Care should be taken to avoid the use of numbers or other designations that have been assigned to Interstate, U.S., or State routes in the same geographic area. Overlapping numbered routes should be kept to a minimum.*

Standard:

- 05 **Route systems shall be given preference in this order: Interstate, United States, State, and county. The preference shall be given by installing the highest-priority legend on the top or the left of the sign.**
- 05A **The route numbers shown on Figure 2D-100 shall be used on route markers.**

Support:

- 05B Table 2D-100 provides a description of the numbered routes in Figure 2D-100.

Figure 2D-100. Alaska Numbered Routes

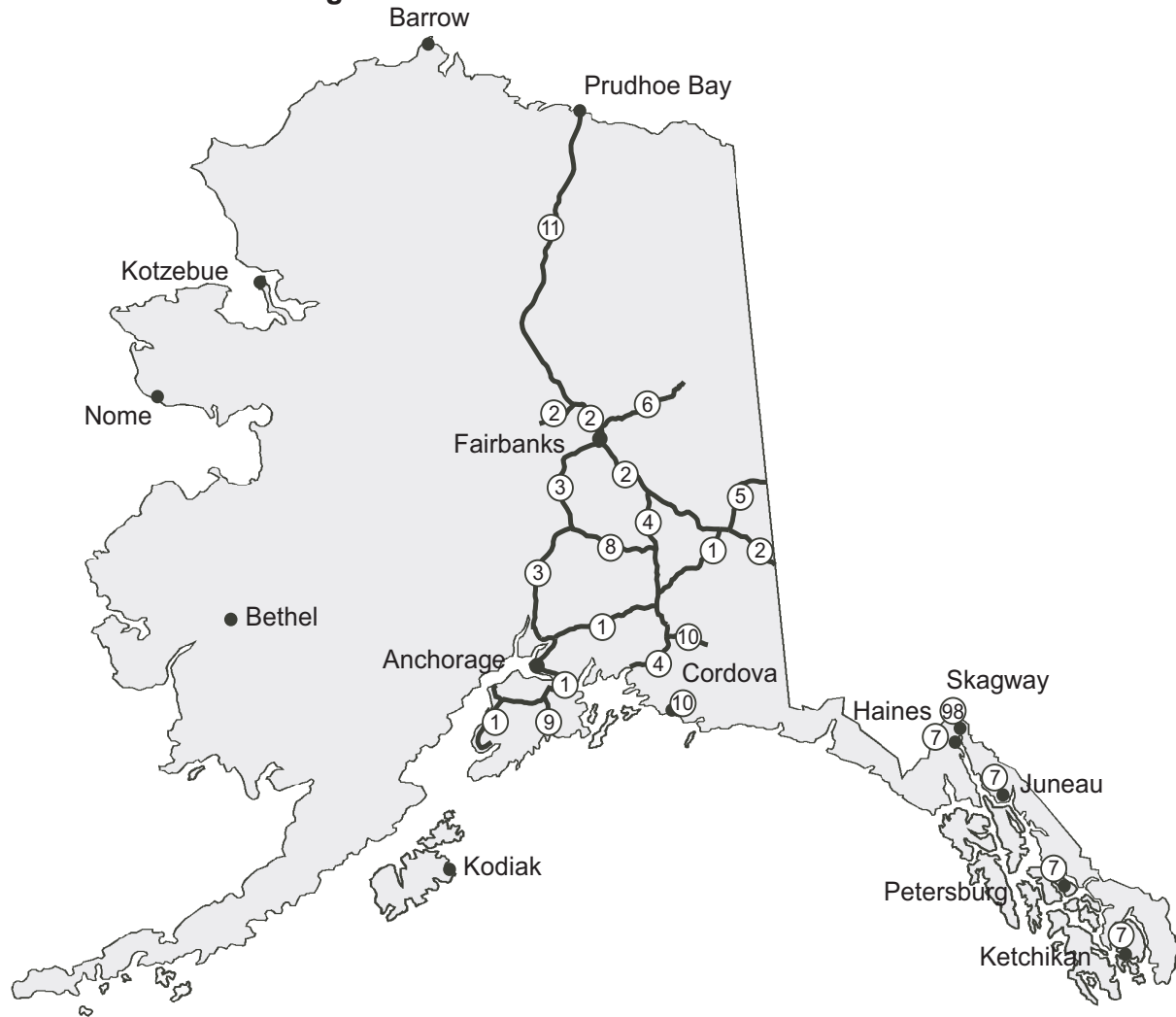

Table 2D-100. Description of Numbered Routes Shown on Figure 2D-100

Route Number	Route Description and Termini Intermediate Junctions, Destinations	Cardinal Direction
AK-1	Homer to Tok, via:	N – S
	Sterling Hwy, Homer to junction with Seward Hwy	
	Seward Hwy, junction with Sterling Hwy to Anchorage	
	Glenn Hwy, Anchorage to Glennallen	
	Richardson Hwy, Glennallen to Gakona Junction	
	Tok Cutoff, Gakona to Tok	
AK-2	Canadian border to Manley Hot Springs, via:	E – W
	Alaska Hwy, Canadian border to Delta Junction	
	Richardson Hwy, Delta Junction to Fairbanks	
	Steese Hwy, Fairbanks to junction with Elliott Hwy	
	Elliott Hwy, junction with Steese Hwy to Manley Hot Springs	
AK-3	Parks-Glenn intersection to Fairbanks, via:	N – S
	George Parks Hwy, junction with Glenn Hwy to junction with Mitchell Expy in Fairbanks	
	Mitchell Expy, junction with Parks Hwy to junction with Richardson Hwy	
AK-4	Valdez to Delta Junction via Richardson Hwy	N – S
AK-5	Tetlin junction to Canadian border via Taylor Hwy	N – S
AK-6	Elliott/Steese junction to Circle via Steese Hwy	E – W
AK-7	Major highways in Southeast, including:	N – S
	South Tongass Hwy, North Tongass Hwy (Ketchikan)	
	Nordic Drive, Mitkoff Hwy (Petersburg)	
	Glacier Hwy, Egan Drive (Juneau)	
	Haines Hwy, Haines to Border	
AK-8	Parks Hwy to Richardson Hwy via Denali Hwy	E – W
	Denali Hwy, Cantwell to Paxson	
AK-9	Seward Hwy, Seward to junction with Sterling Hwy	N – S
AK-10	Copper River Hwy, Cordova to Richardson/Edgerton Highway	E – W
	Copper River Hwy, Cordova to end	
	Edgerton Hwy, McCarthy to junction with Richardson Hwy	
AK-11	Elliott/Dalton junction to Prudhoe Bay via James Dalton Hwy	N – S
AK-98	Skagway to Canadian border via Klondike Hwy	N – S

Support:

- 06 Section 2D.53 contains information regarding the signing of unnumbered highways to enhance route guidance and facilitate travel.

Section 2D.11 Design of Route Signs

Standard:

- 08 U.S. Route signs (see Figure 2D-3) shall consist of black numerals on a white shield surrounded by a rectangular black background without a border. This sign shall be used on all U.S. routes and in connection with route sign assemblies on intersecting highways.
- 09 A 24 x 24-inch minimum sign size shall be used for U.S. route numbers with one or two digits, and a 30 x 24-inch minimum sign size shall be used for U.S. route numbers having three digits.

~~10 State Route signs shall be designed by the individual State highway agencies.~~

10A Route Markers for all Numbered State Highways shall be M1-5 signs as shown in the ASDS.

Section 2D.36 Destination and Distance Signs

Support:

01 In addition to guidance by route numbers, it is desirable to supply the road user information concerning the destinations that can be reached by way of numbered or unnumbered routes. This is done by means of Destination signs and Distance signs.

Option:

02 Route shields and cardinal directions may be included on the Destination sign with the destinations and arrows.

Guidance:

03 *If Route shields and cardinal directions are included on a Destination sign, the height of the route shields should be at least two times the height of the upper-case letters of the principal legend and not less than 18 inches, and the cardinal directions should be in all upper-case letters that are at least the minimum height specified for these signs.*

Standard:

03A The control and intermediate destinations in Table 2D-101 shall be used for destination and distance signs.

Option:

03B In addition to control and intermediate destinations, hamlets and unincorporated communities may be shown on destination signs on state roads when allowed by the agency with road jurisdiction.

Table 2D-101. Destination Control Cities for Alaska Guide Signs

Road Segment	Route Number(s)	Control Destinations	Intermediate Destinations
Sterling Highway, Homer to Soldotna	1	Homer, Anchorage	Soldotna, Kenai
Sterling Highway, Soldotna to Seward "Y"	1	Homer, Anchorage, Seward	Soldotna, Kenai
Seward Highway, Seward to Seward "Y"	9	Seward, Homer, Anchorage	Kenai Fjords Nat. Park
Seward Highway, Seward "Y" to Anchorage	1	Homer, Seward, Anchorage	Girdwood, Whittier Access, Hope Road Junction
Glenn Highway, Anchorage to Parks/Glenn junction	1	Anchorage, Fairbanks, Tok	Eagle River, Palmer
Parks Highway, Parks/Glenn junction to Fairbanks	3	Anchorage, Fairbanks	Wasilla, Cantwell, Denali Nat. Park, Healy, Nenana
Glenn Highway, Parks/Glenn junction to Glennallen	1	Anchorage, Valdez, Tok	Palmer, Glennallen
Tok Cutoff Highway, Gakona Junction to Tok	1	Anchorage, Tok	Glennallen
Richardson Highway, Valdez to Glennallen	4	Valdez, Fairbanks, Anchorage	Edgerton junction, Glennallen, Delta Jct.
Richardson Highway, Glennallen to Gakona Junction	4, 1	Valdez, Fairbanks, Anchorage	Edgerton junction, Glennallen, Delta Jct.
Richardson Highway, Gakona Junction to Delta Jct.	4	Valdez, Fairbanks, Anchorage	Edgerton junction, Glennallen, Delta Jct.
Alaska Highway, Border to Tok	2	Border, Fairbanks, Anchorage	Taylor Hwy Jct.
Alaska Highway, Tok to Delta Junction	2	Tok, Fairbanks	
Alaska Highway, Delta Jct. to Fairbanks	2	Tok, Fairbanks, Anchorage	Eielson AFB, North Pole
Steese/Elliott/Dalton, Fairbanks to Prudhoe Bay	2, 11	Fairbanks, Prudhoe Bay	Coldfoot

Section 2D.37 Destination Signs (D1 Series)

Guidance:

00A *Destination signs should only be used where they will provide a significant service to motorists.*

Support:

00B In addition to guidance by route markers, it is necessary to direct traffic to communities and other destinations on the route and on other roads intersecting the state route.

00C It is not feasible to place signs along highways listing all possible destinations that can be reached from the highway. Normally, a single community, facility, or other feature readily identifiable from a road map can be used to direct motorists to other destinations on the same route. Make every effort to correlate destination signs with features readily identifiable on conventional service station tourist maps.

Guidance:

00D *The following criteria should be met before a directional sign can be considered. However, they are not warrants and do not guarantee placement of signs. On state highways, it is the responsibility of the regional traffic and safety engineer to consider other factors such as interference with higher-priority signing and other destinations that now or in the future will compete for sign space.*

00E *Signs can direct to the following places, consistent with the foregoing discussion:*

- A. *Incorporated cities*
- B. *Unincorporated cities*
- C. *Major parks or mountains*
- D. *Lakes and mountain passes in areas where there are no other places of greater importance*
- E. *Rivers, valleys, and other geographical points if they identify areas, and*
- F. *Sports arenas, fairgrounds, and other public or private attractions that are major driver attractions*

00F *Consider the following information when deciding whether to sign the following types of destinations:*

- A. *Military installations, churches, city parks, public buildings, businesses, subdivisions, clubs, shopping centers, courthouses, zoos, museums, and other local places normally will not be signed. Signing can be considered for a non-qualifying facility that is the principal destination from the interchange or cross road, and which cannot be identified with a road or community. To qualify, such a facility should be located where there is no qualifying destination sign and motorists could not reasonably be expected to find their destination without signs, even with the aid of a map.*
- B. *Sign dams, reservoirs, mountain peaks, and other geographical features only when necessary to indicate direction or to identify areas; or if they are the principal destination served by a cross road, and cannot be identified with a road name or community.*
- C. *Airports that have regularly scheduled commercial air travel and mail pickup, or airports that are owned and operated by political subdivisions, can be signed from conventional highways and expressways. On freeways, sign only to those airports that have regularly scheduled air carrier and mail service, or where there is an off-ramp that serves the airport as either the only or the principal destination. Use AIRPORT (I-5) or appropriate D7-series signs unless there are two or more airports with significant traffic within a municipality.*

Standard:

01 **Except on approaches to interchanges (see Section 2D.45), the Destination (D1-1 through D1-3) sign (see Figure 2D-7), if used, shall be a horizontal rectangle displaying the name of a city, town, village, or other traffic generator, and a directional arrow.**

Option:

02 The distance (see Section 2D.41) to the place named may also be displayed on the Destination (D1-1a through D1-3a) sign (see Figure 2D-7). If several destinations are to be displayed at a single point, the several names may be placed on a single sign with an arrow (and the distance, if desired) for each name. If more than one destination lies in the same direction, a single arrow may be used for such a group of destinations.

Guidance:

03 *Adequate separation should be made between any destinations or group of destinations in one direction and those in other directions by suitable design of the arrow, spacing of lines of legend, heavy lines entirely across the sign, or separate signs.*

Support:

04 Separation of destinations by direction by the use of a horizontal separator line can enhance the readability of a Destination sign by relating an arrow and its corresponding destination(s) and by eliminating the need for multiple arrows that point in the same direction and excessive space between lines of legend.

Standard:

05 **Except as otherwise provided in this Manual, an arrow pointing to the right shall be at the extreme right of the sign, and an arrow pointing left or up shall be at the extreme left. The distance numerals, if used, shall be placed to the right of the destination names.**

Option:

06 An arrow pointing up may be placed at the extreme right of the sign when the sign is mounted to the left of the traffic to which it applies.

Guidance:

07 *Unless a sloping arrow will convey a clearer indication of the direction to be followed, the directional arrows should be horizontal or vertical.*

08 *If several individual name signs are assembled into a group, all signs in the assembly should be of the same horizontal width.*

09 *Destination signs should be used:*

- A. *At the intersections of U.S. or State numbered routes with Interstate, U.S., or State numbered routes; and*
- B. *At points where they serve to direct traffic from U.S. or State numbered routes to the business section of towns, or to other destinations reached by unnumbered routes.*

Standard:

10 **Where a total of three or less destinations are provided on the Advance Guide (see Section 2E.33) and Supplemental Guide (see Section 2E.35) signs, no more than three destination names shall be used on a Destination sign. Where four destinations are provided by the Advance Guide and Supplemental Guide signs, no more than four destination names shall be used on a Destination sign.**

Guidance:

11 *If space permits, four destinations should be displayed as two separate signs at two separate locations.*

Option:

12 Where space does not permit, or where all four destinations are in one direction, a single sign may be used. Where a single sign is used and all destinations are in the same direction, the arrow may be placed below the destinations for the purpose of enhancing the conspicuity of the arrow.

Standard:

13 **Where a single four-name sign assembly is used, a heavy line entirely across the sign or separate signs shall be used to separate destinations by direction.**

Guidance:

14 *The closest destination lying straight ahead should be at the top of the sign or assembly, and below it the closest destinations to the left and to the right, in that order. The destination displayed for each direction should ordinarily be the next county seat or the next principal city, rather than a more distant destination. In the case of overlapping routes, only one destination should be displayed in each direction for each route.*

Standard:

15 **If more than one destination is displayed in the same direction, the name of a nearer destination shall be displayed above the name of a destination that is further away.**

Section 2D.42 Location of Distance Signs

Guidance:

- 01 *If used, Distance signs should be installed on important routes leaving municipalities and just beyond intersections of numbered routes in rural areas. If used, they should be placed just outside the municipal limits or at the edge of the built-up area if it extends beyond the limits.*
- 02 *Where overlapping routes separate a short distance from the municipal limits, the Distance sign at the municipal limits should be omitted. The Distance sign should be installed approximately 300 feet beyond the separation of the two routes.*
- 03 *Where, just outside of an incorporated municipality, two routes are concurrent and continue concurrently to the next incorporated municipality, the top name on the Distance sign should be that of the place where the routes separate; the bottom name should be that of the city to which the greater part of the through traffic is destined.*

Support:

- 04 Figure 2D-6 shows typical placements of Distance signs.

Guidance:

- 04A *Signing in advance of major intersections on a state-numbered route in rural areas should consist of a non-mileage destination (D1-1, D1-2 or D1-3) sign, located up to 1,200 feet in advance of the intersection. Provide appropriate clearances from directional assemblies (see 2D.32) and advance warning signs (Sections 2C-36 and 2C-46).*
- 04B *A D1 series sign should be followed with a Distance Sign (D2-1, D2-2 or D2-3) beyond the intersection (see Section 2D.41 and 2D.42).*
- 04C *On minor state highways that are not through routes, with an ADT of 500 or less, only the mileage destination sign D1-1A, D1-2A, or D1-3A should be used.*

Option:

- 04D *A MILEAGE DESTINATION sign (D1-1A, D1-2A, or D1-3A) may be located either on the near-right quadrant of the intersection (adjacent to the R1-1 STOP sign), head-on at the intersection, or 200 feet in advance of it.*
- 04E *Either mileage or non-mileage destination signs may be used as needed on channelized intersections.*
- 04F *Because the Destination sign is of lesser importance than the Junction, Advance Route Turn, or Directional assemblies, the Destination sign may be eliminated when sign spacing is critical.*

Section 2D.43 Street Name Signs (D3-1 or D3-1a)

Standard:

- 00A **Overhead Street Name (D3-1c or D3-2b) signs shall be installed on all expressways and major arterials at signalized intersections to indicate the location and name of roadways. They shall be installed overhead and to the far right-hand side of the intersection on traffic signal poles or mast arms. When mounted on the mast arm, they shall be horizontal.**

Guidance:

- 01 *Street Name (D3-1 or D3-1a) signs (see Figure 2D-10) or D3-1e sign should be installed in urban areas at all street intersections regardless of other route signs that might be present and should be installed in rural areas to identify important roads that are not otherwise signed.*
- 01A *Overhead Street Name (D3-1c and D3-2b) signs should be installed at all signalized intersections that are not on expressways and major arterials to indicate the location and name of roadways. They should be installed overhead and to the far right-hand side of the intersection on traffic signal poles or mast arms. When mounted on the mast arm, they shall be horizontal.*

Option:

- 02 *For streets that are part of a U.S., State, or county numbered route, a D3-1a Street Name sign (see Figure 2D-10) that incorporates a route shield may be used to assist road users who might not otherwise be able to associate the name of the street with the route number.*

Standard:

03 **The lettering for names of streets and highways on Street Name signs shall be composed of a combination of lower-case letters with initial upper-case letters (see Section 2A.13).**

Guidance:

04 *Lettering on post-mounted Street Name signs should be composed of initial upper-case letters at least 6 inches in height and lower-case letters at least 4.5 inches in height.*

05 *On multi-lane streets with speed limits greater than 40 mph, the lettering on post-mounted Street Name signs should be composed of initial upper-case letters at least 8 inches in height and lower-case letters at least 6 inches in height.*

Option:

06 For local roads with speed limits of 25 mph or less, the lettering on post-mounted Street Name signs may be composed of initial upper-case letters at least 4 inches in height and lower-case letters at least 3 inches in height.

Guidance:

07 *If overhead Street Name signs are used, the lettering should be composed of initial upper-case letters at least 12 inches in height and lower-case letters at least 9 inches in height.*

Option:

07A Smaller letters (8" upper case /6" lower case, but no smaller than 6" upper case/4.5" lower case) may be used when existing mast arms are not strong enough to support signs with larger lettering.

Support:

08 The recommended minimum letter heights for Street Name signs are summarized in Table 2D-2.

Option:

09 Supplementary lettering to indicate the type of street (such as Street, Avenue, or Road) or the section of the city (such as NW) on the D3-1 and D3-1a signs may be in smaller lettering, composed of initial upper-case letters at least 3 inches in height and lower-case letters at least 2.25 inches in height. Conventional abbreviations (see Section 1A.15) may be used except for the street name itself.

10 A pictograph (see definition in Section 1A.13) may be used on a D3-1 sign.

Standard:

11 **Pictographs shall not be displayed on D3-1a or Advance Street Name (D3-2) signs (see Section 2D.44).**

12 **If a pictograph is used on a D3-1 sign, the height and width of the pictograph shall not exceed the upper-case letter height of the principal legend of the sign.**

Guidance:

13 *The pictograph should be positioned to the left of the street name.*

Standard:

14 **The Street Name sign shall be retroreflective or illuminated to show the same shape and similar color both day and night. The color of the legend (and border, if used) shall contrast with the background color of the sign.**

Option:

15 The border may be omitted from a Street Name sign.

16 An alternative background color other than the normal guide sign color of green may be used for Street Name (D3-1 or D3-1a) signs where the highway agency determines this is necessary to assist road users in determining jurisdictional authority for roads.

Standard:

17 **Alternative background colors shall not be used for Advance Street Name (D3-2) signs (see Section 2D.44).**

18 **The only acceptable alternative background colors for Street Name (D3-1 or D3-1a) signs shall be blue, brown, or white. Regardless of whether green, blue, or brown is used as the background color for Street Name (D3-1 or D3-1a) signs, the legend (and border, if used) shall be white. For Street Name signs that use a white background, the legend (and border, if used) shall be black.**

Guidance:

- ¹⁹ *An alternative background color for Street Name signs, if used, should be applied to the Street Name (D3-1 or D3-1a) signs on all roadways under the jurisdiction of a particular highway agency.*
- ²⁰ *In business or commercial areas and on principal arterials, Street Name signs should be placed at least on diagonally opposite corners. In residential areas, at least one Street Name sign should be mounted at each intersection. Signs naming both streets should be installed at each intersection. They should be mounted with their faces parallel to the streets they name.*

Option:

- ²¹ To optimize visibility, Street Name signs may be mounted overhead. Street Name signs may also be placed above a regulatory or STOP or YIELD sign with no required vertical separation.

Guidance:

- ²² *In urban or suburban areas, especially where Advance Street Name signs for signalized and other major intersections are not used, the use of overhead Street Name signs should be strongly considered.*

Option:

- ²³ At intersection crossroads where the same road has two different street names for each direction of travel, both street names may be displayed on the same sign along with directional arrows.

Support:

- ²⁴ Information regarding the use of street names on supplemental plaques for use with intersection-related warning signs is contained in Section 2C.58.

Section 2D.44 Advance Street Name Signs (D3-2)

Support:

- ⁰¹ Advance Street Name (D3-2) signs (see Figure 2D-10) identify an upcoming intersection. Although this is often the next intersection, it could also be several intersections away in cases where the next signalized intersection is referenced.

Standard:

- ⁰² **Advance Street Name (D3-2) signs, if used, shall supplement rather than be used instead of the Street Name (D3-1) signs at the intersection.**

Option:

- ⁰³ Advance Street Name (D3-2) signs may be installed in advance of signalized or unsignalized intersections to provide road users with advance information to identify the name(s) of the next intersecting street to prepare for crossing traffic and to facilitate timely deceleration and/or lane changing in preparation for a turn.

Guidance:

- ⁰⁴ *On arterial highways in rural areas, Advance Street Name signs should be used in advance of all signalized intersections and in advance of all intersections with exclusive turn lanes.*
- ⁰⁵ *In urban areas, Advance Street Name signs should be used in advance of all signalized intersections on major arterial streets, except where signalized intersections are so closely spaced that advance placement of the signs is impractical.*
- ^{05A} *Advance Street Name (D3-1C or D3-2) signs should be installed on major arterials and expressways in advance of major intersections. They should be installed at least 300 to 600 feet in advance of the intersection on rural roads and one-half block in advance of major intersections in urban areas, where the 300- to 600-foot distance cannot be met.*
- ⁰⁶ *The heights of the letters on Advance Street Name signs should be the same as those used for Street Name signs (see Section 2D.43).*

Standard:

- ⁰⁷ **If used, Advance Street Name signs shall have a white legend and border on a green background.**
- ⁰⁸ **If used, Advance Street Name signs shall provide the name(s) of the intersecting street(s) on the top line(s) of the legend and the distance to the intersecting streets or messages such as NEXT SIGNAL, NEXT INTERSECTION, NEXT ROUNDABOUT, or directional arrow(s) on the bottom line of the legend.**

09 **Pictographs shall not be displayed on Advance Street Name signs.**

Option:

10 Directional arrow(s) may be placed to the right or left of the street name or message such as NEXT SIGNAL, as appropriate, rather than on the bottom line of the legend. Curved-stem arrows may be used on Advance Street Name signs on approaches to circular intersections.

11 For intersecting crossroads where the same road has a different street name for each direction of travel, the different street names may be displayed on the same Advance Street Name sign along with directional arrows.

12 In advance of two closely-spaced intersections where it is not practical to install separate Advance Street Name signs, the Advance Street Name sign may include the street names for both intersections along with appropriate supplemental legends for both street names, such as NEXT INTERSECTION, 2ND INTERSECTION, or NEXT LEFT and NEXT RIGHT, or directional arrows.

Guidance:

13 *If two street names are used on the Advance Street Name sign, the street names should be displayed in the following order:*

- A. *For a single intersection where the same road has a different street name for each direction of travel, the name of the street to the left should be displayed above the name of the street to the right; or*
- B. *For two closely-spaced intersections, the name of the first street encountered should be displayed above the name of the second street encountered, and the arrow associated with the second street encountered should be an advance arrow, such as the arrow shown on the W16-6P arrow plaque (see Figure 2C-12).*

Option:

14 An Advance Street Name (W16-8P or W16-8aP) plaque (see Section 2C.58) with black legend on a yellow background, installed supplemental to an Intersection (W2 series) or Advance Traffic Control (W3 series) warning sign may be used instead of an Advance Street Name guide sign.

Section 2D.47 Parking Area Guide Sign (D4-1)

Option:

01 The Parking Area (D4-1) guide sign (see Figure 2D-10) may be used to show the direction to a nearby public parking area or parking facility.

Standard:

02 **If used, the Parking Area (D4-1) guide sign shall be a horizontal rectangle with a standard size of 30 x 24 inches, or with a smaller size of 18 x 15 inches for minor, low-speed streets. It shall carry the word PARKING, with the letter P five times the height of the remaining letters, and a directional arrow. The legend and border shall be green on a retroreflectorized white background.**

02A **The PARKING AREA (D4-1) sign shall not be used on rural routes.**

Guidance:

03 *If used, the Parking Area guide sign should be installed on major thoroughfares at the nearest point of access to the parking facility and where it can advise drivers of a place to park. The sign should not be used more than four blocks from the parking area.*

Section 2D.55 National Scenic Byways Signs (D6-4, D6-4a)

Support:

01 Certain roads have been designated by the U.S. Secretary of Transportation as National Scenic Byways or All-American Roads based on their archeological, cultural, historic, natural, recreational, or scenic qualities.

Option:

02 State and local highway agencies may install the National Scenic Byways (D6-4 or D6-4a) signs at entrance points to a route that has been recognized by the U.S. Secretary of Transportation as a National Scenic Byway or an All-American Road. The D6-4 or D6-4a sign may be installed on route sign assemblies (see Figure 2D-22) or as part of larger roadside structures. National Scenic Byways signs may also be installed at periodic intervals along the designated route and at intersections where the designated route turns or follows a different numbered highway. At locations where roadside features have been developed to enhance the traveler's experience such

as rest areas, historic sites, interpretive facilities, or scenic overlooks, the National Scenic Byways sign may be placed on the associated sign assembly to inform travelers that the site contributes to the byway travel experience.

Standard:

- 03 **When a National Scenic Byways sign is installed on a National Scenic Byway or an All-American Road, the design shown for the D6-4 or D6-4a sign in Figure 2D-22 shall be used. Use of this design shall be limited to routes that have been designated as a National Scenic Byway or All-American Road by the U.S. Secretary of Transportation.**
- 04 **If used, the D6-4 or D6-4a sign shall be placed such that the roadway route signs have primary visibility for the road user.**

Guidance:

- 04A *When a road is both an Alaska Scenic Byway and a National Scenic Byway, AMERICA'S BYWAYS (D6-4a) signs should be installed below each Alaska Scenic Byway sign (I-170 and I-171) on the same post.*

Standard:

- 04B **The installation of either Alaska or National Scenic Byway signs on state highways shall require approval from the DOT&PF Alaska Scenic Byway coordinator.**

Support:

- 04C Alaska Scenic Byways signs (I-170 and I-171) may only be installed on officially designated Alaska Scenic Byways. When possible, exact sites for signs will be specified. Direct questions to Alaska DOT/PF Scenic Byways coordinator at 907-465-8769. A list of the officially designated Alaska Scenic Byways routes can be obtained from the Scenic Byway coordinator.

Guidance:

- 04D *The Scenic Byway with legend (I-171) sign should be installed at both ends of each designated road segment facing entering traffic and on major side road approaches to the segment. Number of these signs required per byway is two plus the number of major side road approaches.*
- 04E *The Scenic Byway without legend (I-170) sign should be installed along the Scenic Byway at a spacing of approximately 15 miles. Desirably, they would be installed in advance of a scenic view in a location where they will not block that view. Putting the signs where they have a backdrop of trees, rock, or an embankment is preferable to putting them where they will be silhouetted by an open view.*
- 04F *The Scenic Byways signs should be installed at least 300 feet away from existing signs and should never block another sign from view. The signs should be located 500 to 1000 feet away from the last sign going away from an intersecting roadway.*

Section 2D.100 Community Service Sign (D9-204)

[This is a new section. There is no corresponding section in the MUTCD.]

Option:

- 01 Community Services signs may be installed to provide direction to communities and to identify services available there. They are a single-sign alternative to multiple business-identifying (D9-205 TODS, LG-series LOGO, or general service D9 series) signs.

Standard:

- 02 **Where Community Service signs are installed, existing TODS and LOGO signs shall be removed.**
- 03 **Community Service signs shall not contain logos that are included on nearby General Service Signs.**
- 04 **A Community Service sign shall not be installed unless there is an accepted community organization that will recommend which of the services available will be represented by icons on the sign.**

Support:

- 05 Community boundaries may be marked with Community Service (D9-204) signs, General Service (D9-201 or similar) signs, WELCOME TO (I-101) signs, or with a landscaped sign outlined in plants etc. On state highways, a beautification permit is required to do the latter.

Guidance:

⁰⁶ *Community Service signs should not be installed for:*

- A. Small communities with two or fewer businesses that offer food, gas, or lodging, or would qualify for Tourist Oriented Directional (D9-204) signs, or*
- B. 1st class cities or other large communities that offer so many services that the icons on the Community Service sign would not adequately represent them.*

⁰⁷ *Icons for police, emergency services, or hospitals should not be shown on Community Service signs. Where signing for these purposes is needed, separate signs should be used.*

CHAPTER 2E. GUIDE SIGNS—FREEWAYS AND EXPRESSWAYS

Section 2E.13 Designation of Destinations

Standard:

- ⁰¹ The direction of a freeway and the major destinations or control cities (see Sections 2D.09, 2D.36, and 2D.37) along it shall be clearly identified through the use of appropriate destination legends (~~see Section 2D.37~~). Successive freeway guide signs shall provide continuity in destination names and consistency with available map information. At any decision point, a given destination shall be indicated by way of only one route.

CHAPTER 2H. GENERAL INFORMATION SIGNS

Section 2H.02 General Information Signs (I Series)

Support:

01 Of interest to the traveler, though not directly necessary for guidance, are numerous kinds of information that can properly be conveyed by General Information signs (see Figure 2H-1) or miscellaneous information signs (see Section 2H.04). They include such items as State lines, city limits, other political boundaries, time zones, stream names, elevations, landmarks, and similar items of geographical interest, and safety and transportation-related messages. Chapter 2M contains recreational and cultural interest area symbol signs that are sometimes used in combination with General Information signs.

Guidance:

02 *General Information signs should not be installed within a series of guide signs or at other equally critical locations, unless there are specific reasons for orienting the road user or identifying control points for activities that are clearly in the public interest. On all such signs, the designs should be simple and dignified, devoid of any advertising, and in general compliance with other guide signing.*

Standard:

03 **Except for political boundary signs, General Information signs shall have white legends and borders on green rectangular-shaped backgrounds.**

Option:

04 An information symbol sign (I-5 through I-9) may be used to identify a route leading to a transportation or general information facility, or to provide additional guidance to the facility. The symbol sign may be supplemented by an educational plaque where necessary; also, the name of the facility may be used if needed to distinguish between similar facilities.

05 The Advance Turn (M5 series) or Directional Arrow (M6 series) auxiliary signs shown in Figure 2H-1 with white arrows on green backgrounds may be used with General Information symbol signs to create a General Information Directional Assembly.

06 Guide signs for commercial service airports and non-carrier airports may be provided from the nearest Interstate, other freeway, or conventional highway intersection directly to the airport, normally not to exceed 15 miles. The Airport (I-5) symbol sign along with a supplemental plaque may be used to indicate the specific name of the airport. An Airport symbol sign, with or without a supplemental name plaque or the word AIRPORT, and an arrow may be used as a trailblazer.

Standard:

07 **Adequate trailblazer signs shall be in place prior to installing the airport guide signs.**

Support:

08 Location and placement of all airport guide signs depends upon the availability of longitudinal spacing on highways.

Option:

09 The Recycling Collection Center (I-11) symbol sign may be used to direct road users to recycling collection centers.

Guidance:

10 *The Recycling Collection Center symbol sign should not be used on freeways and expressways.*

Standard:

11 **If used on freeways or expressways, the Recycling Collection Center symbol sign shall be considered one of the supplemental sign destinations.**

12 **When a sign is used to display a safety or transportation-related message, the display format shall not be of a type that would be considered similar to advertising displays. Messages and symbols that resemble any official traffic control device shall not be used on safety or transportation-related message signs.**

Option:

- ¹³ The pictograph of a political jurisdiction (such as a State, county, or municipal corporation) may be displayed on a political boundary General Information sign.

Standard:

- ¹⁴ **If used, the height of a pictograph on a political boundary General Information sign shall not exceed two times the height of the upper-case letters of the principal legend on the sign. The pictograph shall comply with the provisions of Section 2A.06.**

Option:

- ^{14A} The ENTERING ALASKA TIME ZONE sign (I-182) may be installed at highway border crossings facing traffic entering Alaska.
- ^{14B} The REPORT EVERY DANGEROUS DRIVER IMMEDIATELY (REDDI) sign (I-191) and the REDDI 911 sign (I-192) may be used in a Safety Zone (corridor) as established under the Safety Zone Signing section of Section 2B.17. Install REDDI signs (I-191) at the beginning of a Safety corridor following the BEGIN HIGHWAY SAFETY ZONE sign (R16-112). Install REDDI 911 signs (I-192) within the Safety corridor at intervals of approximately 10 miles. REDDI 911 signs may also be installed after intersections that introduce significant traffic into the corridor.

Section 2H.05 Reference Location Signs (D10-1 through D10-3) and Intermediate Reference Location Signs (D10-1a through D10-3a)

Support:

- ^{00A} In the ATMS, “Reference Location Signs and Intermediate Reference Location Signs” (as the MUTCD refers to them) are called “Milepost (D10-101 through D10-104) and Intermediate Milepost Signs (D10-101A through D10-104A).”
- ⁰¹ There are two types of reference location signs:
- A. Reference Location (D10-1, 2, and 3) signs show an integer distance point along a highway, and
 - B. Intermediate Reference Location (D10-1a, 2a, and 3a) signs also show a decimal between integer distance points along a highway.

Standard:

- ⁰² **Except when Enhanced Reference Location signs (see Section 2H.06) are used instead, Reference Location (D10-1 through D10-3) signs shall be placed on all expressway facilities that are located on a route where there is reference location sign continuity and on all freeway facilities to assist road users in estimating their progress, to provide a means for identifying the location of emergency incidents and traffic crashes, and to aid in highway maintenance and servicing.**

Option:

- ⁰³ Reference Location (D10-1 to D10-3) signs (see Figure 2H-2) may be installed along any section of a highway route or ramp to assist road users in estimating their progress, to provide a means for identifying the location of emergency incidents and traffic crashes, and to aid in highway maintenance and servicing.
- ⁰⁴ To augment the reference location sign system, Intermediate Reference Location (D10-1a to D10-3a) signs (see Figure 2H-3), which show the tenth of a mile with a decimal point, may be installed at one tenth of a mile intervals, or at some other regular spacing.

Standard:

- ⁰⁵ **When Intermediate Reference Location (D10-1a to D10-3a) signs are used to augment the reference location sign system, the reference location sign at the integer mile point shall display a decimal point and a zero numeral.**
- ⁰⁶ **When placed on freeways or expressways, reference location signs shall contain 10-inch white numerals on a 12-inch wide green background with a white border. The signs shall be 24, 36, or 48 inches in height for one, two, or three digits, respectively, and shall contain the word MILE in 4-inch white letters.**
- ⁰⁷ **When placed on conventional roads, reference location signs shall contain 6-inch white numerals on a green background that is at least 10 inches wide with a white border. The signs shall contain the word MILE in 4-inch white letters.**
- ^{07A} **The design details for reference location and intermediate reference location signs shall be as shown in the ASDS.**

08 **Reference location signs shall have a minimum mounting height of 4 feet, measured vertically from the bottom of the sign to the elevation of the near edge of the roadway, and shall not be governed by the mounting height requirements prescribed in Section 2A.18.**

09 **The distance numbering shall be continuous for each route within a State, except where overlaps occur (see Section 2E.31). Where routes overlap, reference location sign continuity shall be established for only one of the routes. If one of the overlapping routes is an Interstate route, that route shall be selected for continuity of distance numbering.**

09A **Where two routes become the same roadway, only the reference location or intermediate reference location signs for the lower number state route shall be installed. However, when the routes again diverge, the mileage for the higher numbered route shall resume as if it had continued through the combined section.**

Guidance:

10 *The route selected for continuity of distance numbering should also have continuity in interchange exit numbering (see Section 2E.31).*

11 *On a route without reference location sign continuity, the first reference location sign beyond the overlap should indicate the total distance traveled on the route so that road users will have a means of correlating their travel distance between reference location signs with that shown on their odometer.*

Standard:

12 **For divided highways, the distance measurement shall be made on the northbound and eastbound roadways. The reference location signs for southbound or westbound roadways shall be set at locations directly opposite the reference location signs for the northbound or eastbound roadways.**

Guidance:

13 *Zero distance should begin at the south and west State lines, or at the south and west terminus points where routes begin within a State.*

Standard:

14 **Except as provided in Paragraph 15, reference location signs shall be installed on the right-hand side of the roadway.**

14A **When reference location and intermediate reference location signs are already in place and the reference does not match the requirements of Paragraph 12 and 13 they should be have the reference location or intermediate reference location signs located on the right side of the road in the direction of increasing route mileage. For divided highways the distance measurement shall be made on the roadway segment in the direction of increasing mileage. The reference location or intermediate reference location signs for the opposite direction should be placed directly opposite the reference location.**

14B **On two-lane conventional roadways, reference location and intermediate reference location signs shall be installed on one side of the roadway only and shall be installed back-to-back with one legend visible from each direction of travel. Reference location and intermediate reference location signs shall be placed 15 to 30 feet from the edge of traveled way.**

Option:

15 *Where conditions limit or restrict the use of reference location signs on the right-hand side of the roadway, they may be installed in the median. ~~On two-lane conventional roadways, reference location signs may be installed on one side of the roadway only and may be installed back-to-back. Reference location signs may be placed up to 30 feet from the edge of the pavement.~~*

16 *If a reference location sign cannot be installed in the correct location, it may be moved in either direction as much as 50 feet.*

Guidance:

17 *If a reference location sign cannot be placed within 50 feet of the correct location, it should be omitted.*

Support:

17A **Because reference location and intermediate reference location signs are used as permanent location references on Alaska highways for residences, businesses, and topographical features, they are not ordinarily changed when a road segment is reconstructed or realigned, and therefore do not necessarily correspond to actual mileage along a route.**

Guidance:

^{17B} *When a road is realigned in a manner that either shortens or lengthens the road, reference location signs locations should be interpolated between existing reference location signs on either side of the realigned segment. Reference location and intermediate reference location signs before or beyond the realigned section should not be adjusted to reflect the change in route mileage.*

Section 2H.06 Enhanced Reference Location Signs (D10-4, D10-5)

Support:

^{00A} In the ATMS, “Enhanced Reference Location Signs and Enhanced Intermediate Reference Signs” (as the MUTCD refers to them) are called “Enhanced Milepost Signs and Enhanced Intermediate Milepost Signs.”

~~⁰⁴ There are two types of enhanced reference location signs:~~

- ~~A. Enhanced Reference Location signs (D10-4), and~~
- ~~B. Intermediate Enhanced Reference Location signs (D10-5).~~

Option:

~~⁰² Enhanced Reference Location (D10-4) signs (see Figure 2H-4), which enhance the reference location sign system by identifying the route, may be placed on freeways or expressways (instead of Reference Location signs) or on conventional roads.~~

~~⁰³ To augment an enhanced reference location sign system, Intermediate Enhanced Reference Location (D10-5) signs (see Figure 2H-4), which show the tenth of a mile with a decimal point, may be installed along any section of a highway route or ramp at one tenth of a mile intervals, or at some other regular spacing.~~

Standard:

~~⁰⁴ If enhanced reference location signs are used, they shall be vertical signs having blue or green backgrounds with white numerals, letters, and borders, except for the route shield, which shall be the standard color and shape. The top line shall consist of the cardinal direction for the roadway. The second line shall consist of the applicable route shield for the roadway. The third line shall identify the mile reference for the location and the bottom line of the Intermediate Enhanced Reference Location sign shall give the tenth of a mile reference for the location. The bottom line of the Intermediate Enhanced Reference Location sign shall contain a decimal point. The height of the legend on enhanced reference location signs shall be a minimum of 6 inches. The height of the route shield on enhanced reference location signs shall be a minimum of 12 inches.~~

~~⁰⁵ The background color shall be the same for all enhanced reference location signs within a jurisdiction.~~

Support:

~~⁰⁶ The provisions in Section 2H.05 regarding mounting height, distance numbering and measurements, sign continuity, and placement with respect to the right-hand shoulder and/or median for reference location signs also apply to enhanced reference location signs.~~

Section 2H.08 Acknowledgment Signs

Standard:

^{00A} Except as described in Paragraphs 00B and 00C, Acknowledgment Signs shall not be used in Alaska.

^{00B} Adopt-a-Highway (I-150) signs on state roads shall be installed and maintained in accordance with DOT&PF Policy and Procedure 07.05.010.

^{00C} Adopt-a-Bike Path (I-151) signs on state pathways shall be installed and maintained in accordance with pertinent parts of DOT&PF Policy and Procedure 07.05.010.

CHAPTER 2I. GENERAL SERVICE SIGNS

[Delete signs D9-20 and D9-20aP from Figure 2I-1 General Service Signs and Plaques.]

Section 2I.02 General Service Signs for Conventional Roads

Support:

~~01 On conventional roads, commercial services such as gas, food, and lodging generally are within sight and are available to the road user at reasonably frequent intervals along the route. Consequently, on this class of road there usually is no need for special signs calling attention to these services. Moreover, General Service signing is usually not required in urban areas except for hospitals, law enforcement assistance, tourist information centers, and camping.~~

01A Due to the sparse settlement of rural Alaska, it can be advantageous to place motorist service signs on conventional roads. General Service signing is usually not required in urban areas except for hospitals, law enforcement assistance, tourist information centers, and camping. General Service signs are installed for the benefit of the motorist, not to promote businesses.

01B Other signs for businesses are listed in Table 2A-101.

Option:

~~02 General Service signs (see Figure 2I-1) may be used where such services are infrequent and are found only on an intersecting highway or crossroad.~~

Standard:

03 All General Service signs and supplemental sign panels shall have white letters, symbols, arrows, and borders on a blue background.

03A General Service (D9 series) signs (see Figure 2I-1 of the MUTCD) shall be installed only when the particular service is available within one mile of the intersection and the facility or a sign for the facility is not visible to the approaching motorist until they are within 800 feet of the turn off to the facility. An exception to the visibility requirement can be made for hospitals and Emergency Medical Service facilities.

03B The sign(s) shall be covered or removed when the service is no longer available, such as at a seasonal facility.

03C The particular services shall also meet all of the requirements listed below for that service.

- A. A camping area (D9-3 series, D9-4 series, or D9-100 sign) is typically located adjacent to a lake, creek, or river in an area with scenic, historic, or recreational interest such as a trailhead. It may include a firewood stock, shelters, a developed water supply, and sanitary dump facilities for campers or trailers. It must include a parking area, picnic tables, litter disposal facilities, toilets, and locations where campers may be parked and/or tents erected.
- B. A parking area (D9-105 sign) is generally more modest than a rest area and does not include toilets. It may include picnic tables, and must include litter disposal facilities and at least a 1,600-square-foot area separate from the highway for vehicles to park. The typical truck turnout created by widening the roadway is not considered a parking area since it is not separate from the roadway.
- C. A scenic viewpoint (D9-102 sign) is a turnout or parking area with a particularly attractive view of an identified feature.
- D. A food service facility (D9-6 sign) is a café, snack bar, or restaurant permitted by the Alaska Department of Environmental Conservation. As a minimum, it must provide hot food and beverages, modern sanitation facilities, and be open for business to the public at least 16 hours per day, seven days a week. Public telephones are desirable.
- E. Telephones (D9-1 series sign) qualify if they are readily accessible to the public for all types of calls 24 hours per day, seven days per week.
- F. Gas Stations (D9-7, D9-11 signs) may be identified if the facility sells both motor oil and gasoline in commercial quantities from pumps licensed by the Department of Transportation and Public Facilities Division of Measurement Standards and Commercial Vehicle Enforcement, at least 16 hours per day, seven days a week. The availability of diesel fuel, tires, electrical service, restrooms, an automobile hoist, and qualified service technician shall be considered in the case of competing facilities.

- G. Lodging (D9-9 sign) must consist of at least beds and bedding in a permanent, allweather, heated building equipped with toilet and bathing facilities for at least 10 hours per night throughout the week. The facility should have at least six rooms available for guests.
- H. A hospital (D9-2 sign) is a permanent medical facility that serves the public with 24-hour emergency medical service and has a licensed physician readily available. The Pharmacy (D9-20 or D9-20a plaque) signs shall not be used in Alaska.

Option:

- 03D HOSPITAL (D9-2) signs and EMERGENCY MEDICAL SERVICE (D9-13) symbol signs may be installed within urban areas. Mark each turn from the adjacent major or through highway to the emergency service entrance to the facility with additional signs and appropriate directional arrows and/or distance plaques.
- 03E CAMPING [D9-3 series, D9-4 series, and the RV PARK (D9-100)], the SANITARY DUMP (D9-12), PUBLIC DUMPSTER (D9-230), and TOURIST INFORMATION (D9-10) signs may be used in urban areas, but should be kept to a minimum.
- 03F The D9 series signs may be supplemented with Arrow and/or Distance plaques on conventional highways and expressways in advance of the turn to the facility to aid the motorist.

Support:

- 03G Consider using 1 MILE (D9-306) as well as 1500 FT (D9-308) plaques mounted below the Camping (D9-3 series, D9-4 series, and D9-100) signs to allow motorists additional time to make the decision to use these facilities.

Guidance:

- 04 *General Service signs should be installed at a suitable distance in advance of the turn-off point or intersecting highway.*
- 05 *States that elect to provide General Service signing should establish a statewide policy or warrant for its use, and criteria for the availability of services. Local jurisdictions electing to use such signing should follow State policy for the sake of uniformity.*

Option:

- 06 Individual States may sign for whatever alternative fuels are available at appropriate locations.

Standard:

- 07 **General Service signs, if used at intersections, shall be accompanied by a directional message.**

Option:

- 08 The Advance Turn (M5 series) or Directional Arrow (M6 series) auxiliary signs with white arrows on blue backgrounds as shown in Figure 2I-1 may be used with General Service symbol signs to create a General Service Directional Assembly.
- 09 The General Service sign legends may be either symbols or word messages.

Standard:

- 10 **~~Symbols and word message General Service legends shall not be intermixed on the same sign. The Pharmacy (D9-20) sign shall only be used to indicate the availability of a pharmacy that is open, with a State-licensed pharmacist present and on duty, 24 hours per day, 7 days per week, and that is located within 3 miles of an interchange on the Federal-aid system. The D9-20 sign shall have a 24 HR (D9-20aP) plaque mounted below it.~~**

Support:

- 11 Formats for displaying different combinations of these services are described in Section 2I.03.

Guidance:

- 11A *The NEXT SERVICES XX MILES (D9-210) sign, should be used only when next services are 50 miles or further away.*

Option:

- ~~12 If the distance to the next point at which services are available is 10 miles or more, a NEXT SERVICES XX MILES (D9-17P) plaque (see Figure 2I-2) may be installed below the General Service sign.~~
- 13 The International Symbol of Accessibility for the Handicapped (D9-6) sign may be used beneath General Service signs where paved ramps and rest room facilities accessible to, and usable by, the physically handicapped are provided.

Guidance:

¹⁴ *When the D9-6 sign is used in accordance with Paragraph 13, and van-accessible parking is available at the facility, a VAN ACCESSIBLE (D9-6P) plaque (see Figure 2I-1) should be mounted below the D9-6 sign.*

Option:

¹⁵ The Recreational Vehicle Sanitary Station (D9-12) sign may be used as needed to indicate the availability of facilities designed for the use of dumping wastes from recreational vehicle holding tanks.

¹⁶ The Litter Container (D9-4) sign may be placed in advance of roadside turnouts or rest areas, unless it distracts the driver's attention from other more important regulatory, warning, or directional signs.

¹⁷ The Emergency Medical Services (D9-13) symbol sign may be used to identify medical service facilities that have been included in the Emergency Medical Services system under a signing policy developed by the State and/or local highway agency.

Standard:

~~¹⁸ The Emergency Medical Services symbol sign shall not be used to identify services other than qualified hospitals, ambulance stations, and qualified free-standing emergency medical treatment centers. If used, the Emergency Medical Services symbol sign shall be supplemented by a sign identifying the type of service provided.~~

^{18A} **An Emergency Medical Service (Staff-of-Life) (D9-13) sign facility must be staffed by emergency medical technicians certified by the Emergency Services Section, Alaska Department of Health and Social Services; and must be readily accessible and manned 24 hours a day. The signed location should be the dispatch point for the EMS, not necessarily the garage for the ambulance. The Emergency Medical Services symbol shall be supplemented by a sign identifying the type of service provided.**

Option:

¹⁹ The Emergency Medical Services symbol sign may be used above the HOSPITAL (D9-13a) sign or Hospital (D9-2) symbol sign or above a sign with the legend AMBULANCE STATION (D9-13b), EMERGENCY MEDICAL CARE (D9-13c), or TRAUMA CENTER (D9-13d). The Emergency Medical Services symbol sign may also be used to supplement Telephone (D9-1), Channel 9 Monitored (D12-3), or POLICE (D9-14) signs.

Standard:

²⁰ **The legend EMERGENCY MEDICAL CARE shall not be used for services other than qualified free-standing emergency medical treatment centers.**

Guidance:

²¹ *Each State should develop guidelines for the implementation of the Emergency Medical Services symbol sign.*

²² *The State should consider the following guidelines in the preparation of its policy:*

A. AMBULANCE

- 1. 24-hour service, 7 days per week.*
- 2. Staffed by two State-certified persons trained at least to the basic level.*
- 3. Vehicular communications with a hospital emergency department.*
- 4. Operator should have successfully completed an emergency-vehicle operator training course.*

B. HOSPITAL

- 1. 24-hour service, 7 days per week.*
- 2. Emergency department facilities with a physician (or emergency care nurse on duty within the emergency department with a physician on call) trained in emergency medical procedures on duty.*
- 3. Licensed or approved for definitive medical care by an appropriate State authority.*
- 4. Equipped for radio voice communications with ambulances and other hospitals.*

C. Channel 9 Monitored

- 1. Provided by either professional or volunteer monitors.*
- 2. Available 24 hours per day, 7 days per week.*
- 3. The service should be endorsed, sponsored, or controlled by an appropriate government authority to guarantee the level of monitoring.*

Standard:

- 22A On state highways, DAY MEDICAL CLINIC signs (D9-207) shall be installed by permit only. The applicant shall pay all material and installation costs. To be eligible for a permit, a medical clinic shall:**
- A. Be on the approved Alaska medical clinic list maintained by Health Planning and Systems Development section of the Alaska Department of Health and Social Services;**
 - B. Be located at least ten miles (travel distance) away from any hospital;**
 - C. Have at least one mid-level practitioner or physician on duty during all business hours;**
 - D. Be open regular hours and at least 30 hours per week;**
 - E. Be within 5 miles of the highway on which the sign is placed;**
 - F. Not be visible to motorists before they are within 1250 feet of the driveway or road leading to the clinic;**
 - G. Have no advertising signs that are either:**
 - 1. Visible to motorists before they are within 1250 feet of the driveway or road leading to the clinic or**
 - 2. Illegal;**
 - H. Agree to post and maintain accurate business hours on the sign.**

22B No business names or icons shall be shown on the signs.

22C For safety reasons, these signs must display correct business hours. Change, remove, or cover signs immediately when hours become inaccurate. Medical clinics are responsible for ensuring the accuracy of posted business hours.

Option:

22D Time change revisions may be made by fastening a plate made of the same material as the original sign over the hours and days shown on the original sign.

Standard:

22E Day Medical Clinic signs (D9-207) shall not be placed on a freeway or expressway, on an on-ramp or off-ramp of a freeway or expressway, or at a location where a majority of traffic exits the highway at the driveway or intersecting road.

22F Day Medical Clinic signs (D9-207) shall not be posted if it will be confused with other 'Day Medical Clinic' signage in the same area.

Guidance:

22G When placed on state highways, Day Medical Clinic Signs (D9-207), should be located at the intersection of the road leading to the clinic and the nearest state highway with a classification of collector or arterial.

Support:

22H The purpose of Day Medical Clinic signs is to guide motorists to the nearest appropriate location for unplanned medical treatment, especially where distances are great and delay in treatment can impact favorable outcomes. Such signing is not intended to guide motorists with planned medical events or to educate target groups on the availability of treatment from non-hospital providers. Day Medical Clinic direct motorists to the intersecting sidestreet or driveway leading to the clinic, not from arterial to arterial or highway to highway.

22I The location of the applicant's clinic or the location of the driveway or intersection road is not within the urban portion of an organized borough that exceeds 2,500 residents, or first class and second class cities.

Option:

22J Wayfinding signs may be required at turning points after leaving the main road.

Guidance:

22K No more than one D9-207 sign should be posted in each direction on the main roadway, and no more than one additional D9-207 sign should be used to post a turn from the secondary roadway.

Support:

22L Multiple turns from the secondary roadway are not recommended as a motorist service for first aid. More than one turn from the secondary roadway is not recommended for highway signage. In those cases, the clinic will instead have to rely upon business advertising for customers.

Section 2I.03 General Service Signs for Freeways and Expressways

Support:

⁰¹ General Service (D9-18 series) signs (see Figure 2I-3) are generally not appropriate at major interchanges (see definition in Section 2E.32) and in urban areas.

Standard:

⁰² **General Service signs shall have white letters, symbols, arrows, and borders on a blue background. Letter and numeral sizes shall comply with the minimum requirements of Tables 2E-2 through 2E-5. All approved symbols shall be permitted as alternatives to word messages, but symbols and word service messages shall not be intermixed. If the services are not visible from the ramp of a single-exit interchange, the service signing shall be repeated in smaller size at the intersection of the exit ramp and the crossroad. Such service signs shall use arrows to indicate the direction to the services.**

^{02A} **The Pharmacy (D9-20 or D9-20a plaque) signs shall not be used in Alaska.**

Option:

⁰³ For numbered interchanges, the exit number may be incorporated within the sign legend (D9-18b) or displayed on an Exit Number (E1-5P) plaque (see Section 2E.31).

Guidance:

⁰⁴ *Distance to services should be displayed on General Service signs where distances are more than 1 mile.*

⁰⁵ *General Service signing should only be provided at locations where the road user can return to the freeway or expressway and continue in the same direction of travel.*

⁰⁶ *Only services that fulfill the needs of the road user should be displayed on General Service signs. If State or local agencies elect to provide General Service signing, there should be a statewide policy for such signing and criteria for the availability of the various types of services. The criteria should consider the following:*

A. Gas, Diesel, LP Gas, EV Charging, and/or other alternative fuels if all of the following are available:

- 1. Vehicle services such as gas, oil, and water;*
- 2. Modern sanitary facilities and drinking water;*
- 3. Continuous operations at least 16 hours per day, 7 days per week; and*
- 4. Public telephone.*

B. Food if all of the following are available:

- 1. Licensing or approval, where required;*
- 2. Continuous operation to serve at least two meals per day, at least 6 days per week;*
- 3. Public telephone; and*
- 4. Modern sanitary facilities.*

C. Lodging if all of the following are available:

- 1. Licensing or approval, where required;*
- 2. Adequate sleeping accommodations;*
- 3. Public telephone; and*
- 4. Modern sanitary facilities.*

D. Public Telephone if continuous operation, 7 days per week is available.

E. Hospital if continuous emergency care capability, with a physician on duty 24 hours per day, 7 days per week is available. A physician on duty would include the following criteria and should be signed in accordance with the priority as follows:

- 1. Physician on duty within the emergency department;*
- 2. Registered nurse on duty within the emergency department, with a physician in the hospital on call; or*
- 3. Registered nurse on duty within the emergency department, with a physician on call from office or home.*

~~F. 24-Hour Pharmacy if a pharmacy is open, with a State-licensed pharmacist present and on duty, 24 hours per day, 7 days per week and is located within 3 miles of an interchange on the Federal-aid system.~~

G. Camping if all of the following are available:

1. Licensing or approval, where required;
2. Adequate parking accommodations; and
3. Modern sanitary facilities and drinking water.

Standard:

07 **For any service that is operated on a seasonal basis only, the General Service signs shall be removed or covered during periods when the service is not available.**

08 **The General Service signs shall be mounted in an effective location, between the Advance Guide sign and the Exit Direction sign, in advance of the exit leading to the available services.**

Guidance:

09 *The General Service sign should contain the interchange number, if any, as shown in Figure 2I-3.*

09A *The NEXT SERVICES XX MILES (D9-210) sign, should be used only when next services are 50 miles or further away.*

10 *If the distance to the next point where services are available is greater than 10 miles, a NEXT SERVICES XX MILES (D9-17P) plaque (See figure 2I-2) may be installed below the Exit Direction Sign.*

Standard:

11 **Signs for services shall comply with the format for General Service signs (see Section 2I.02) and as provided in this Manual. No more than six general road user services shall be displayed on one sign, which includes any appended supplemental signs or plaques. General Service signs shall carry the legends for one or more of the following services: Food, Gas, Lodging, Camping, Phone, Hospital, 24-Hour Pharmacy, or Tourist Information.**

12 **The qualified services available shall be displayed at specific locations on the sign.**

13 **To provide flexibility for the future when the service might become available, the sign space normally reserved for a given service symbol or word shall be left blank when that service is not present.**

Guidance:

14 *The standard display of word messages should be FOOD and PHONE in that order on the top line, and GAS and LODGING on the second line. If used, HOSPITAL and CAMPING should be on separate lines (see Figure 2I-3).*

Option:

15 *Signing for DIESEL, LP-Gas, or other alternative fuel services may be substituted for any of the general services or appended to such signs. The International Symbol of Accessibility for the Handicapped (D9-6) sign (see Figure 2I-1) may be used for facilities that qualify.*

Guidance:

16 *When symbols are used for the road user services, they should be displayed as follows:*

A. *Six services:*

1. *Top row—GAS, FOOD, and LODGING*
2. *Bottom row—PHONE, HOSPITAL, and CAMPING*

B. *Four services:*

1. *Top row—GAS and FOOD*
2. *Bottom row—LODGING and PHONE*

C. *Three services:*

1. *Top row—GAS, FOOD, and LODGING*

Option:

17 *Substitutions of other services for any of the services described in Paragraph 16 may be made by placing the substitution in the lower right (four or six services) or extreme right (three services) portion of the sign. An action message or an interchange number may be used for symbol signs in the same manner as they are used*

for word message signs. The Diesel Fuel (D9-11) symbol or the LP-Gas (D9-15) symbol may be substituted for the symbol representing fuel or appended to such assemblies. The Tourist Information (D9-10) symbol ~~or the 24-Hour Pharmacy (D9-20 and D9-20aP) symbol~~ may be substituted on any of the configurations provided in Paragraph 16.

18 At rural interchange areas where limited road user services are available and where it is unlikely that additional services will be provided within the near future, a supplemental plaque displaying one to three services (words or symbols) may be appended below a post-mounted interchange guide sign.

Standard:

19 **If more than three services become available at rural interchange areas where limited road user services were anticipated, the appended supplemental plaque described in Paragraph 18 shall be removed and replaced with an independently mounted General Service sign as described in this Section.**

Option:

20 A separate Telephone Service (D9-1) sign (see Figure 2I-1) may be installed if telephone facilities are located adjacent to the route at places where public telephones would not normally be expected.

21 The Recreational Vehicle Sanitary Station (D9-12) sign (see Figure 2I-1) may be used as needed to indicate the availability of facilities designed for dumping wastes from recreational vehicle holding tanks.

22 In some locations, signs may be used to indicate that services are not available.

23 A separate Truck Parking (D9-16) sign (see Figure 2I-1) may be mounted below the other general road user services to direct truck drivers to designated parking areas.

[Delete the Pharmacy icon from the D9-18 sign and the word Pharmacy from the D9-18a sign on Figure 2E-42 Examples of General Service Signs (with Exit Numbering)]

Section 2I.04 Interstate Oasis Signing

Standard:

00A **Interstate Oasis Signing shall not be used in Alaska.**

Section 2I.05 Rest Area and Other Roadside Area Signs

Standard:

01 **Rest Area signs (see Figure 2I-5) shall have a retroreflective white legend and border on a blue background.**

02 **Signs that include the legend REST AREA shall be used only where parking, picnic tables, litter disposal, and restroom facilities are available.**

Guidance:

03 *A roadside area that does not contain restroom facilities should be signed to indicate the major road user service that is provided. For example, the sign legends for an area with only parking should use the words PARKING AREA instead of REST AREA. The sign legends for an area with only picnic tables and parking should use words such as PICNIC AREA, ROADSIDE TABLE, or ROADSIDE PARK instead of REST AREA.*

04 *Rest areas that have tourist information and welcome centers should be signed as discussed in Section 2I.08.*

05 *Scenic area signing should be consistent with that provided for rest areas, except that the legends should use words such as SCENIC AREA, SCENIC VIEW, or SCENIC OVERLOOK instead of REST AREA.*

06 *If a rest area or other roadside area is provided on a conventional road, a D5-1 and/or D5-1a sign should be installed in advance of the rest area or other roadside area to permit the driver to reduce speed in preparation for leaving the highway. A D5-5 sign (or a D5-2 sign if an exit ramp is provided) should be installed at the turnoff point where the driver needs to leave the highway to access the rest area or other roadside area.*

07 *If a rest area or other roadside area is provided on a freeway or expressway, a D5-1 sign should be placed 1 mile and/or 2 miles in advance of the rest area.*

Standard:

08 **A D5-2a sign shall be placed at the rest area or other roadside area exit gore.**

Option:

- ⁰⁹ A D5-1a sign may be placed between the D5-1 sign and the exit gore on a freeway or expressway. A second D5-1 sign may be used in place of the D5-1a sign with a distance to the nearest 1/2 or 1/4 mile displayed as a fraction rather than a decimal for distances of less than 1 mile.
- ¹⁰ To provide the road user with information on the location of succeeding rest areas, a NEXT REST AREA XX MILES (D5-6) sign (see Figure 2I-5) may be installed independently or as a supplemental sign mounted below one of the REST AREA advance guide signs.
- ^{10A} Scenic areas may be marked by the SCENIC VIEW Symbol (D9-102) sign. Follow the guidelines for D9 series signs in Section 2I.02.

Standard:

- ¹¹ **All signs on freeways and expressways for rest and other roadside areas shall have letter and numeral sizes that comply with the minimum requirements of Tables 2E-2 through 2E-5. The sizes for General Service signs that have standardized designs shall be as shown in Table 2I-1.**

Option:

- ¹² If the rest area has facilities for the physically impaired (see Section 2I.02), the International Symbol of Accessibility for the Handicapped (D9-6) sign (see Figure 2I-1) may be placed with or beneath the REST AREA advance guide sign.
- ¹³ If telecommunication devices for the deaf (TDD) are available at the rest area, the TDD (D9-21) symbol sign (see Figure 2I-1) may be used to supplement the advance guide signs for the rest area.
- ¹⁴ If wireless Internet services are available at the rest area, the Wi-Fi (D9-22) symbol sign (see Figure 2I-1) may be used to supplement the advance guide signs for the rest area.

Section 2I.08 Tourist Information and Welcome Center Signs

Support:

- ⁰¹ Tourist information and welcome centers have been constructed within rest areas on freeways and expressways and are operated by either a State or a private organization. Others have been located within close proximity to these facilities and operated by civic clubs, chambers of commerce, or private enterprise.

Guidance:

- ⁰² *An excessive number of supplemental sign panels should not be installed with Tourist Information or Welcome Center signs so as not to overload the road user.*

Standard:

- ⁰³ **Tourist Information or Welcome Center signs (see Figure 2I-7) shall have a white legend and border on a blue background. Continuously staffed or unstaffed operation at least 8 hours per day, 7 days per week, shall be required.**
- ⁰⁴ **If operated only on a seasonal basis, the Tourist Information or Welcome Center signs shall be removed or covered during the off seasons.**

Guidance:

- ⁰⁵ *For freeway or expressway rest area locations that also serve as tourist information or welcome centers, the following signing criteria should be used:*
- A. The locations for tourist information and welcome center Advance Guide, Exit Direction, and Exit Gore signs should meet the General Service signing requirements described in Section 2I.03.*
 - B. If the signing for the tourist information or welcome center is to be accomplished in conjunction with the initial signing for the rest areas, the message on the Advance Guide (D5-7) sign should be REST AREA, TOURIST INFO CENTER, XX MILES or REST AREA, STATE NAME (optional), WELCOME CENTER XX MILES. On the Exit Direction (D5-8 or D5-11) sign the message should be REST AREA, TOURIST INFO CENTER with a diagonally upward-pointing directional arrow (or NEXT RIGHT), or REST AREA, STATE NAME (optional), WELCOME CENTER with a diagonally upward-pointing directional arrow (or NEXT RIGHT).*
 - C. If the initial rest area Advance Guide and Exit Direction signing is in place, these signs should include, on supplemental signs, the legend TOURIST INFO CENTER or STATE NAME (optional), WELCOME*

CENTER.

- D. *The Exit Gore sign should contain only the legend REST AREA with the arrow and should not be supplemented with any legend pertaining to the tourist information center or welcome center.*

Option:

- ⁰⁶ An alternative to the supplemental TOURIST INFO CENTER legend is the Tourist Information (D9-10) sign (see Figure 2I-1), which may be appended beneath the REST AREA advance guide sign.
- ⁰⁷ The name of the State or local jurisdiction may appear on the Advance Guide and Exit Direction tourist information/welcome center signs if the jurisdiction controls the operation of the tourist information or welcome center and the center meets the operating criteria set forth in this Manual and is consistent with State policies.

Standard:

- ^{07A} **TOURIST INFORMATION CENTER (I-200) signs may be installed when the applicant meets the following criteria:**

- A. **There shall be a minimum of 10 off-street parking spaces provided.**
- B. **The tourist information center shall be located adjacent to the highway.**
- C. **The tourist information center shall have information about the surrounding region as well as the area near the center.**

- ^{07B} **Applicants for these signs shall submit an official designation as a Tourist Information Center from the local city or borough government and letter of concurrence from the local Chamber of Commerce to the appropriate city or regional traffic and safety engineer. Applicants shall not fabricate or install signs until approval from the city or regional traffic engineer is obtained.**

- ^{07C} **Only one center should be designated for communities located along a single major through route. Multiple visitor centers may be designated for larger communities with a network of several major through routes. These should be limited to no more than one for each entry point to the community. Visitor/information centers shall be located within the community or region they serve.**

- ^{07D} **The name of the operating agency, community, group, or enterprise shall not appear in the legend of the sign.**

- ^{07E} **The operating agency shall purchase and install the original signs.**

Guidance:

- ⁰⁸ *For tourist information centers that are located off the freeway or expressway facility, additional signing criteria should be as follows:*

- A. *Each State should adopt a policy establishing the maximum distance that a tourist information center can be located from the interchange in order to be included on official signs.*
- B. *The location of signing should be in accordance with requirements pertaining to General Service signing (see Section 2I.03).*
- C. *Signing along the crossroad should be installed to guide the road user from the interchange to the tourist information center and back to the interchange.*

Option:

- ⁰⁹ As an alternative, the Tourist Information (D9-10) sign (see Figure 2I-1) may be appended to the guide signs for the exit that provides access to the tourist information center. As a second alternative, the Tourist Information sign may be combined with General Service signing.

CHAPTER 2J. SPECIFIC SERVICE SIGNS

Section 2J.01 Eligibility

Standard:

- 01 **Specific Service signs shall be defined as guide signs that provide road users with business identification and directional information for services and for eligible attractions. Eligible service categories shall be limited to gas, food, lodging, camping, attractions, and 24-hour pharmacies.**
- 01A **Specific Service signs shall only be used for motorist services in Alaska. They shall not be used for attractions or for pharmacies. They shall only be installed on freeways and expressways.**

Guidance:

- 02 *The use of Specific Service signs should be limited to areas primarily rural in character or to areas where adequate sign spacing can be maintained.*

Option:

- ~~03 Where an engineering study determines a need, Specific Service signs may be used on any class of highways.~~

Guidance:

- 04 *Specific Service signs should not be installed at an interchange where the road user cannot conveniently reenter the freeway or expressway and continue in the same direction of travel.*

Standard:

- 05 **Eligible service facilities shall comply with laws concerning the provisions of public accommodations without regard to race, religion, color, age, sex, or national origin, and laws concerning the licensing and approval of service facilities.**

~~06 The attraction services shall include only facilities which have the primary purpose of providing amusement, historical, cultural, or leisure activities to the public.~~

~~07 Distances to eligible 24-hour pharmacies shall not exceed 3 miles in any direction of an interchange on the Federal-aid system.~~

Guidance:

- ~~08 Except as provided in Paragraph 9, distances to eligible services other than pharmacies should not exceed 3 miles in any direction.~~

Option:

- ~~09 If, within the 3-mile limit, facilities for the services being considered other than pharmacies are not available or choose not to participate in the program, the limit of eligibility may be extended in 3-mile increments until one or more facilities for the services being considered chooses to participate, or until 15 miles is reached, whichever comes first.~~

Guidance:

- 10 *If State or local agencies elect to provide Specific Service signing, there should be a statewide policy for such signing and criteria for the availability of the various types of services. The criteria should consider the following:*
- A. *To qualify for a GAS logo sign panel, a business should have:*
 1. *Vehicle services including gas and/or alternative fuels, oil, and water;*
 2. *Continuous operation at least 16 hours per day, 7 days per week for freeways and expressways, and continuous operation at least 12 hours per day, 7 days per week for conventional roads;*
 3. *Modern sanitary facilities and drinking water; and*
 4. *Public telephone.*
 - B. *To qualify for a FOOD logo sign panel, a business should have:*
 1. *Licensing or approval, where required;*
 2. *Continuous operations to serve at least two meals per day, at least 6 days per week;*
 3. *Modern sanitary facilities; and*

4. Public telephone.
- C. To qualify for a LODGING logo sign panel, a business should have:
 1. Licensing or approval, where required;
 2. Adequate sleeping accommodations;
 3. Modern sanitary facilities; and
 4. Public telephone.
- D. To qualify for a CAMPING logo sign panel, a business should have:
 1. Licensing or approval, where required;
 2. Adequate parking accommodations; and
 3. Modern sanitary facilities and drinking water.
- ~~E. To qualify for an ATTRACTION logo sign panel, a facility should have:

 1. Regional significance, in compliance with the provisions of Paragraph 6; and
 2. Adequate parking accommodations.~~

Standard:

~~11 If State or local agencies elect to provide Specific Service signing for pharmacies, both of the following criteria shall be met for a pharmacy to qualify for signing:~~

~~A. The pharmacy shall be continuously operated 24 hours per day, 7 days per week, and shall have a State-licensed pharmacist present and on duty at all times; and~~

~~B. The pharmacy shall be located within 3 miles of an interchange on the Federal-aid system.~~

Support:

~~12 Section 2I.04 contains information regarding the Interstate Oasis program.~~

Section 2J.02 Application

Standard:

~~01 The number of Specific Service signs along an approach to an interchange or intersection, regardless of the number of service types displayed, shall be limited to a maximum of four. In the direction of traffic, successive Specific Service signs shall be for 24-hour pharmacy, attraction, camping, lodging, food, and gas services, in that order.~~

01A Specific Service (LOGO) signs shall be permitted and installed in accordance with 17 AAC 60.101 through 17 AAC 60.120 and 17 AAC 60.905 through AAC 60.995.

02 A Specific Service sign shall display the word message GAS, FOOD, LODGING, or CAMPING, ~~ATTRACTION, or 24-HOUR PHARMACY~~, an appropriate directional legend such as the word message EXIT XX, NEXT RIGHT, SECOND RIGHT, or directional arrows, and the related logo sign panels.

03 No more than three types of services shall be represented on any sign or sign assembly. If three types of services are displayed on one sign, then the logo sign panels shall be limited to two for each service type (for a total of six logo sign panels). If two types of services are displayed on one sign, then the logo sign panels shall be limited to either three for each service type (for a total of six logo sign panels) or four for one service type and two for the other service type (for a total of six logo sign panels). The legend and logo sign panels applicable to a service type shall be displayed such that the road user will not associate them with another service type on the same sign.

04 No service type shall appear on more than two signs (see Paragraph 6).

05 The signs shall have a blue background, a white border, and white legends of upper-case letters, numbers, and arrows.

Section 2J.03 Logos and Logo Sign Panels

Option:

~~†5—If a business designated as an Interstate Oasis (see Section 2I.04) has a business logo sign panel on the Food and/or Gas Specific Service signs, the word OASIS may be displayed on the bottom portion of the logo sign panel for that business.~~

Section 2J.11 Signing Policy

Standard:

^{00A} **Specific Service (LOGO) signs shall be permitted and installed in accordance with 17 AAC 60.101 through 17 AAC 60.120 and 17 AAC 60.905 through AAC 60.995.**

~~Guidance:~~

~~†4—Each highway agency that elects to use Specific Service signs should establish a signing policy that includes, as a minimum, the guidelines of Section 2J.01 and at least the following criteria:~~

- ~~A. Selection of eligible businesses;~~
- ~~B. Distances to eligible services;~~
- ~~C. The use of logo sign panels, legends, and signs conforming with this Manual and State design requirements;~~
- ~~D. Removal or covering of logo sign panels during off seasons for businesses that operate on a seasonal basis;~~
- ~~E. The circumstances, if any, under which Specific Service signs are permitted to be used in non-rural areas; and~~
- ~~F. Determination of the costs to businesses for initial permits, installations, annual maintenance, and removal of logo sign panels.~~

CHAPTER 2K. TOURIST-ORIENTED DIRECTIONAL SIGNS

Section 2K.06 Sign Locations

Standard:

- 00A When placed on state highways, Tourist-Oriented Directional (D9-205) signs (TODS) shall be located at the intersection of the road leading to the attraction and the nearest state highway with a classification of collector or arterial.

Guidance:

- 01 If used, the intersection approach signs should be located at least 200 feet in advance of the intersection. Signs should be spaced at least 200 feet apart and at least 200 feet from other traffic control devices.
- 02 If used, advance signs should be located approximately 1/2 mile from the intersection with 500 feet between these signs. In the direction of travel, the order of advance sign placement should be to show the destinations to the left first, then destinations to the right, and last, the destinations straight ahead.
- 03 Position, height, and lateral offset of signs should be governed by Chapter 2A except as permitted in this Section.

Option:

- 04 Tourist-oriented directional signs may be placed farther from the edge of the road than other traffic control signs.

Standard:

- 05 The location of other traffic control devices shall take precedence over the location of tourist-oriented directional signs.
- 05A When placed on state highways, Tourist-Oriented Directional (D9-205) signs shall not be installed farther than 1 mile in advance of the intersection identified in the Standard statement above, or at a different intersection, without written permission of the regional traffic and safety engineer.

Section 2K.07 State Policy

Standard:

- 01 To be eligible for tourist-oriented directional signing, facilities shall comply with applicable State and Federal laws concerning the provisions of public accommodations without regard to race, religion, color, age, sex, or national origin, and with laws concerning the licensing and approval of service facilities. ~~Each State that elects to use tourist-oriented directional signs shall adopt a policy that complies with these provisions.~~
- 01A Tourist-Oriented Directional (D9-205) signs (TODS) shall be permitted and installed in accordance with 17 AAC 60.001 through 17 AAC 60.020 and 17 AAC 60.905 through AAC 60.995.

Guidance:

~~02 The State policy should include:~~

- ~~A. A definition of tourist-oriented business, service, and activity facilities.~~
- ~~B. Eligibility criteria for signs for facilities.~~
- ~~C. Provision for incorporating Specific Service signs into the tourist-oriented directional signs as required by Paragraph 5 of Section 2K.01.~~
- ~~D. Provision for covering signs during off seasons for facilities operated on a seasonal basis.~~
- ~~E. Provisions for signs to facilities that are not located on the crossroad when such facilities are eligible for signs.~~
- ~~F. A definition of the immediate area in compliance with the provisions of Paragraph 2 of Section 2K.01.~~
- ~~G. Maximum distances to eligible facilities. The maximum distance should be 5 miles.~~
- ~~H. Provision for information centers (plazas) when the number of eligible sign applicants exceeds the maximum permissible number of sign panel installations.~~
- ~~I. Provision for limiting the number of signs when there are more applicants than the maximum number of signs permitted.~~

J. Criteria for use at intersections on expressways.

K. Provisions for controlling or excluding those businesses which have illegal signs as defined by the Highway Beautification Act of 1965 (23 U.S.C. 131).

L. Provisions for States to charge fees to cover the cost of signs through a permit system.

M. A definition of the conditions under which the time of operation is displayed.

N. Provisions for determining if advance signs will be permitted, and the circumstances under which they will be installed.

^{02A} *Tourist-Oriented Directional signs should not be allowed for businesses whose primary purpose is to sell alcohol, such as bars and liquor stores.*

Option:

^{02B} Trailblazing signs may be installed between TODS and the attraction at intersections where a turn is required. Trailblazing signs on state roads require approval of the regional traffic and safety engineer.

Standard:

^{02C} **If used, trailblazing signs shall be General Service Plates (D9-1 to D9-15, D9-100 to D9-106) or signs of the same color with different icons. The icon on the signs shall be the same as the icon on the TODS. Use appropriate arrow and distance plaques.**

CHAPTER 2M. RECREATIONAL AND CULTURAL INTEREST AREA SIGNS

Section 2M.02 Application of Recreational and Cultural Interest Area Signs

Support:

- 01 Provisions for signing recreational or cultural interest areas are subdivided into two different types of signs: (1) symbol signs and (2) destination guide signs.

Standard:

- 01A **Recreational and Cultural Interest Area (RCIA) signs shall be permitted and installed in accordance with 17 AAC 60.201 through 17 AAC 60.215 and 17 AAC 60.905 through 17AAC 60.995.**
- 01B **Logos shall only be shown on RCIA signs when all of the following conditions are met:**
- A. **When the logo represents a public agency.**
 - B. **When the logo is installed on a sign in a rural area.**
 - C. **When logos are recognizable and meaningful to motorists as demonstrated by:**
 - 1. **Inclusion of the logo in an Alaska or U.S. outreach campaign, or**
 - 2. **Relation of the logo to other programs of use to motorists, such as parking pass programs or guide map symbols, or**
 - 3. **Sufficient numbers of logos on signs around the state to become familiar to motorists.**
- 01C **Logos shall not be used solely for the purpose of agency promotion and advertising.**
- 01D **RCIA signs shall only be installed downstream (on the attraction side of) the nearest city or major junction and shall not be installed more than 50 miles from the attraction. When they are installed near the attraction or the road leading to the attraction, RCIA signs shall be located not more than 1,250 feet in advance of the attraction or the road leading to the attraction. On state roads, the DOT&PF alone shall determine whether RCIA signs shall be installed in advance or near the attraction or road leading to the attraction.**
- 01E **When placed on state highways, RCIA signs should be located at the intersection of the road leading to the attraction and the nearest state highway with a classification of collector or arterial.**
- 01F **When Recreational and Cultural Interest Area signs need to be limited due to space restrictions, public Recreational/Cultural attractions shall receive signs before private Recreational/Cultural attractions.**

Guidance:

- ~~02 *When highway agencies decide to provide recreational and cultural interest area signing, these agencies should have a policy for such signing. The policy should establish signing criteria for the eligibility of the various types of services, accommodations, and facilities. These signs should not be used where they might be confused with other traffic control signs.*~~

Section 2M.04 General Design Requirements for Recreational and Cultural Interest Area Symbol Guide Signs

Standard:

- 01 **Recreational and cultural interest area symbol guide signs shall be square or rectangular in shape and shall have a white symbol or message and white border on a brown background. The symbols shall be grouped into the following usage and series categories:**
- A. **General Applications,**
 - B. **Accommodations,**
 - C. **Services,**
 - D. **Land Recreation,**
 - E. **Water Recreation, and**
 - F. **Winter Recreation.**
- 01A **No more than four RS Series symbol signs shall be attached beneath Supplemental Guide signs (Section 2M.09), D7-1, and D7-2 signs. No more than one RS Series symbol sign shall be attached beneath a D7-105 sign.**
- 01B **If used as an allowable symbol sign attached beneath D7-1, D7-2, or D7-105 signs, the Wildlife Viewing (RS-076) symbol sign shall be installed in accordance with Section 2S.03.**

Support:

⁰² Table 2M-1 contains a listing of the symbols within each series category. Drawings showing the design details for these symbols are found in the “Standard Highway Signs and Markings” book (see Section 1A.11).

Option:

⁰³ Mirror images of symbols may be used where the reverse image will better convey the message.

⁰⁴ The Wild and Scenic River (RS-WSR) symbol may be used as one of the allowed symbol signs attached beneath Supplemental Guide (Section 2M.09) signs D7-1, D7-2, or D7-105 if the signing location is related to a river segment in the current listing of the River Mileage Classifications for Components of National Wild And Scenic Rivers System as published by the Interagency Wild and Scenic Rivers Coordinating Council. The WSR symbol may be reproduced in color and in original proportions on a brown plate with a white border meeting the dimensional requirements for the road classification. The symbol may be truncated in the vertical dimension, or the vertical height fitted within the dimensions of the symbol plate.

CHAPTER 2N. EMERGENCY MANAGEMENT SIGNING

Section 2N.03 Evacuation Route Signs (EM-1 and EM-1a)

Support:

00A TSUNAMI EVACUATION ROUTE (EM-100) signs guide people to safe ground when a tidal wave approaches.

Standard:

00B **The signs shall be installed on state highways only after a regional traffic and safety engineer has approved a tsunami evacuation route plan done by the Alaska Division of Homeland Security and Emergency Management (ADHS&EM), formerly the Alaska Division of Emergency Services (ADES). The plan must be done in accordance with the procedure transmitted in a memo from Robert E. Heavilin, ADES Director, to Michael Downing of the DOT&PF on March 16, 1998.**

Guidance:

00C *Communities desiring tsunami evacuation route signs should submit their requests to the ADHS&EM.*

CHAPTER 2S. SPECIAL SIGNS

[This is a new chapter. There is no corresponding chapter in the MUTCD.]

Section 2S.01 Highway Fatality Memorial Signs (I-160 through I-164, and I-167)

Support:

01 Highway Fatality Memorial Signs memorialize victims of fatal highway accidents.

Standard:

02 **When a memorial sign is requested, sign and plate legends shall conform to Table 2S-100.**

Table 2S-100. Highway Fatality Memorial Signs

Conditions	Sign	Deceased Person Being Memorialized	Plate
Caused by Legally Drunk Driver	PLEASE DON'T DRINK AND DRIVE (I-160)	Drunk Driver at fault in crash	Sponsored By (I-163)
		Not at Fault	In Memory Of (I-162)
Not Caused by Legally Drunk Driver, Deceased is a Child Not in an Appropriate Child Safety Seat	PLEASE USE CHILD SAFETY SEATS (I-167)	Not at Fault (child)	In Memory Of (I-162)
Not Caused by Legally Drunk Driver, Deceased Not Wearing Seat Belt	PLEASE BUCKLE UP (I-164)	Driver at fault in crash	Sponsored By (I-163)
		Not at Fault (other than not wearing seat belt)	In Memory Of (I-162)
Not Caused by Legally Drunk Driver, Deceased Wearing Seat Belt	PLEASE DRIVE SAFELY (I-161)	Driver at fault in crash	Sponsored By (I-163)
		Not at Fault	In Memory Of (I-162)

03 **If both IN MEMORY OF . . . (I-162) and SPONSORED BY . . . (I-163) plaques are requested at an accident site, they shall be installed on separate sign installations.**

04 **On I-162 plaques, “IN MEMORY OF” shall be followed by the name of the deceased. On I-163 plaques, “SPONSORED BY” shall be followed by the name of the family, family members, or friends who requested the memorial sign.**

05 **Year of installation stickers shall be placed on the back of each sign.**

06 **Before installation on state highways, the DOT&PF regional office right-of-way chief or designee shall approve the signs as conforming to the Highway Fatality Memorial Sign Program. Applicants for the signs shall comply with program requirements.**

Section 2S.02 State Maintenance Begins/Ends Signs (I-180 and I-181)

Option:

01 The STATE MAINTENANCE BEGINS (I-180) sign may be installed at the point on the roadway where maintenance becomes the responsibility of the Department of Transportation and Public Facilities.

02 The STATE MAINTENANCE ENDS (I-181) signs may be installed at the point on the roadway where maintenance becomes the responsibility of another agency or private party.

Standard:

03 **The I-180 and I-181 signs shall be installed on the right at the maintenance area boundary.**

Section 2S.03 Wildlife Viewing Sign (RS-076)

Option:

01 The Wildlife Viewing (RS-076) sign may be used to direct motorists to wildlife viewing sites identified in Alaska Department of Fish and Game Wildlife Viewing Program publications. These guides include The Alaska Wildlife Viewing Guide (statewide), Anchorage Wildlife Viewing Hotspots, The Fairbanks Area Wildlife Viewing Guide, Alaska’s Kenai Peninsula Wildlife View Trail Guide, Alaska’s South Coastal Wildlife Viewing

Guide, and Alaska's Inside Passage Wildlife Viewing Guide (marine/ferry-based) with related individual community brochures. Other guides may be added. An educational plaque may be installed beneath the symbol sign based on engineering judgment.

Standard:

02 **On state highways, the regional traffic and safety engineer shall approve identified wildlife viewing sites before they are signed.**

03 **The signs shall not be mounted on the same post as regulatory or warning signs.**

Guidance:

04 *The Wildlife Viewing signs should follow the guidelines for D9 series signs. See Section 2I.02.*

Option:

05 The Wildlife Viewing signs may be installed on the same post as guide, recreational, general service, and similar signs.

Section 2S.04 Speedometer Check Station Signs (I-140, I-141B, I-141E and I-142)

Option:

01 Where appropriate, a measured distance (third order accuracy) may be signed on a generally straight roadway section to allow motorists to check odometer accuracy.

Guidance:

02 *The measure section should be at least 5 miles in length. The SPEEDOMETER CHECK STATION AHEAD (I-140) sign should be located 1,500 feet in advance of the BEGIN CHECK MILE 0 sign (I-141B). The MILE 1 through MILE 4 (I-142) signs should be located at the 1 through 4-mile marks, followed by the END CHECK MILE 5 (I-141E) sign.*

Section 2S.05 Customs Station Signing (D8-102, D8-103, D8-104, and R13-103)

Support:

01 The general concept for Customs Station signing is similar to weigh station signing (see Section 2B.60).

Standard:

02 **CUSTOMS (D8-102 through D8-104 and R13-103) signs shall take precedence over all service and information signing. The following four signs shall be installed in sequence toward the facility on all classes of highways:**

- A. **CUSTOMS 1 MILE (D8-102)**
- B. **ALL VEHICLES STOP AT CUSTOMS (R13-103)**
- C. **CUSTOMS 1000 FT OPEN/CLOSED (D8-103)**
- D. **CUSTOMS (Arrow) D8-104R or L**

Section 2S.06 FIRE HYDRANT Sign (M12-1)

Option:

01 The FIRE HYDRANT (M12-1) sign may be used to mark hydrants that are hard to see. A number sequence as designated by the local fire department may be included on the sign.

Section 2S.07 Community Sober Driving Sign Assemblies (I-160, I-165, I-166)

Standard:

01 **Community Sober Driving Sign Assemblies shall consist of:**

- A. **a I-165 “CITY OF XXXX” sign on top, and**
- B. **a I-160 “PLEASE DON’T DRINK AND DRIVE” sign below**

Option:

- 02 An I-166, “X LIVES LOST OVER 10 YRS” sign may be attached below the Community Sober Driving Sign Assembly.

Support:

- 03 Community Don’t Drink and Drive signs are intended to discourage drunk driving. They are intended only for use off the connected Alaska road system (roads on which you can drive to Anchorage without sea or air links) because otherwise every community on the connected road system might end up with these signs at their boundaries. This would tend to diminish the impact of site specific highway fatality memorial signs which are more common on the road system.

Standard:

- 05 **This sign assembly shall only be installed when requested by communities:**
- A. off of the connected Alaska road system,
 - B. with populations less than 5,000, and
 - C. that have experienced one or more fatalities resulting from drunk-driving within the last 10 years.
- 06 **The I-166 sign shall show the actual number of lives lost in the last ten years in road crashes caused by drunk drivers.**
- 07 **Before installation on state highways, the DOT&PF regional office right-of-way chief or designee shall issue a permit for the signs. Applicants shall comply with program requirements.**

Section 2S.08 Pedestrian Wayfinding Signs

Support:

- 01 Pedestrian Wayfinding signs are small signs intended to guide pedestrians to walking destinations in urban areas. No official sign designs are included in the ASDS for Pedestrian Wayfinding signs because 1) they are not road signs, and 2) they are often uniquely designed for each community. General sign design rules are provided below.

Standard:

- 02 **A permit shall be obtained from the regional DOT&PF right of way office before placing a pedestrian wayfinding sign within state highway right of way.**
- If used, pedestrian wayfinding signs shall:**
- A. Have a predominant background color of brown, blue, or green,
 - B. Have letter colors that contrast with the background,
 - C. Where possible, be located and oriented so they are not visible to drivers,
 - D. Use non-retroreflective sign sheeting,
 - E. Not contain advertising or sponsorship messages,
 - F. Not block road signs from view,
 - G. Be located where the signs or sign supports do not reduce pathway clear space to less than that required by the Americans with Disabilities Act (ADA),
 - H. Comply with all other ADA requirements including the use of minimum letter sizes that conform to ADA Accessibility Guidelines requirements.
 - I. Be as small as practical.

Section 2S.09 Game Management Unit/Subsistence Hunt Area signs

Option:

- 01 ENTERING GAME MANAGEMENT UNIT (I-2F) signs and LEAVING GAME MANAGEMENT UNIT (I-2G) signs may be used to mark the boundaries of game management units.
- 02 ENTERING FEDERAL SUBSISTENCE HUNT AREA (I-2H) signs and LEAVING FEDERAL SUBSISTENCE HUNT AREA (I-2J) signs may be used to mark the boundaries of federal subsistence hunt areas.

Standard:

- 03 **DOT&PF Recreational and Cultural permits (17 AAC 60.201 through 17 AAC 60.215 and 17 AAC 60.905 through AAC 60.995) shall be required for Game Management Unit and Subsistence Hunt Area signs prior to installation. The applicant shall be responsible for installing and maintaining the signs.**
- 04 **Game Management Unit and Subsistence Hunt Area signs shall not be posted:**
- A. **Where road contact with the game management unit or subsistence area is less than 10 continuous miles, or**
 - B. **To mark areas smaller than game management sub-units or subsistence hunt areas, or**
 - C. **To mark dates, allowable weapon types, sex of game animals, and similar details regarding hunting within game management units or subsistence hunt areas, or**
 - D. **Where the road does not intersect the game management unit or subsistence area, or**
 - E. **To mark Special Management Areas including, but not limited to, closed areas, controlled use areas, management areas, or refuges, sanctuaries, or habitat areas.**
- 05 **This type of signing shall not be applicable to invasive species control programs, fire district or fire station boundaries, or other similar non-hunt areas.**

Support:

- 06 Because of the large number of year round users in subsistence hunt areas and game units in the aggregate, each individual subsistence hunt area or game unit is considered to satisfy the requirements of 17 AAC 60.205(2). Hunting area boundaries are destinations for many of Alaska's road users such that hunting area boundaries are consistent with other recreational and cultural interest area locations. Conversely, boundaries of areas closed to hunting are not permissible for signing because such areas are not destinations for hunters.
- 07 Game Management Units (GMUs) are defined as numbered areas subdividing the State as established by Alaska Department of Fish and Game. Game Management sub-units, commonly referred to on ADF&G maps and materials as "Units," are subdivisions of GMUs and are denoted with a number and letter designation. Special Management Areas are smaller, generally contained within a GMU or Unit.
- 08 For the purposes of this section, GMUs are hunt areas in Alaska with boundaries described using landmarks and topographical features such as rivers or streams and their drainages, and natural or manmade features. Knowledge of boundary locations is the responsibility of the hunter. Agencies with responsibility for hunting and for game and land management are responsible for dissemination of information regarding hunt area landmarks and all information relating to hunting closures or openings.
- 09 Highway signing informs road users of the intersection of the highway with a hunt area boundary and is not a substitute for hunter knowledge of the hunt area. Conditions on placement minimize potential for motorist confusion and proliferation of signs where boundaries may be in close proximity. Such restrictions are consistent with the purpose of traffic control devices as identified in 1A.01 of the MUTCD which is "to notify road users [of information] needed for the uniform and efficient operation of...the traffic stream..." and with the placement limitation for Recreational and Cultural Interest Area signs according to 17 AAC 60.205 and 17 AAC 60.905 through AAC 60.995. Intersection of the road with a Game Management Unit or Federal Subsistence Hunt Area includes the case where the road defines the boundary of the Game Management Unit or Federal Subsistence Hunt Area.
- 10 Alaska DOT&PF encourages agencies to consider alternatives to highway signing for conveying needed information. Suggested alternatives include: placement of signs outside of the highway right of way and oriented parallel to the traveled way; and coordinating with DOT&PF for locating informational kiosks in pull-outs and parking areas.

Section 2S.10 School Destination Signs

Support:

- 01 School Destination Signs (I-102) are not ordinarily needed by people who attend school every day or by the public who regularly go to and from the school. Instead, the intent of a School Destination Sign is to serve an unfamiliar motorist.

Standard:

- 02 **If used, School Destination Signs shall meet all of the following criteria regarding school size and location:**
- A. **The school serves 10 or more students;**

- B. The school is registered with the Alaska Department of Education & Early Development;**
- C. The school has regularly scheduled and frequent after school events and activities; and**
- D. The school building, onsite property, and direct access on property is not readily visible from the roadway or is not able to be made readily visible through vegetation clearing.**

⁰³ **In addition, if used, School Destination Signs shall meet one or more of the following criteria regarding public utility:**

- A. After school events and activities are attended by motorists with students from other public schools;**
- B. After school events and activities are commonly open to the public in the local area and visitors from around the state;**
- C. The school serves as an publicly designated community meeting hall or community council site;**
- D. The school serves as a voting or public polling station; or**
- E. The school is officially designated as a civil emergency shelter.**

(This page left intentionally blank.)

PART 3

MARKINGS

CHAPTER 3B. PAVEMENT AND CURB MARKINGS

Section 3B.02 No-Passing Zone Pavement Markings and Warrants

Standard:

- 01 **No-passing zones shall be marked by either the one direction no-passing zone pavement markings or the two-direction no-passing zone pavement markings described in Section 3B.01 and shown in Figures 3B-1 and 3B-3.**
- 02 **When center line markings are used, no-passing zone markings shall be used on two-way roadways at lane-reduction transitions (see Section 3B.09) and on approaches to obstructions that must be passed on the right (see Section 3B.10).**
- 03 **On two-way, two- or three-lane roadways where center line markings are installed, no-passing zones shall be established at vertical and horizontal curves and other locations where an engineering study indicates that passing must be prohibited because of inadequate sight distances or other special conditions.**
- 04 **On roadways with center line markings, no-passing zone markings shall be used at horizontal or vertical curves where the passing sight distance is less than the minimum shown in Table 3B-1 (also shown in Table 3B-100) for the 85th-percentile speed or the posted or statutory speed limit. The passing sight distance on a vertical curve is the distance at which an object 3.5 feet above the pavement surface can be seen from a point 3.5 feet above the pavement (see Figure 3B-4). Similarly, the passing sight distance on a horizontal curve is the distance measured along the center line (or right-hand lane line of a three-lane roadway) between two points 3.5 feet above the pavement on a line tangent to the embankment or other obstruction that cuts off the view on the inside of the curve (see Figure 3B-4).**
- 04A **One- and two-direction no-passing zones for one direction of traffic shall be no shorter than 500 feet.**
- 04B **Passing zones for one direction of traffic shall be no shorter than the distances shown in Table 3B-100 at the 85th-percentile speed (when speed data is available), or the posted or statutory speed limit, whichever is higher.**

Guidance:

- 05 ~~Where the distance between successive no-passing zones is less than 400 feet, no-passing markings should connect the zones.~~

Standard:

- 08 **Where center line markings are used, no-passing zone markings shall be used on approaches to grade crossings in compliance with Section 8B.27.**

Option:

- 08A **A one-way no-passing marking may be placed on any approach to an intersection.**

Guidance:

- 08B *If used, no-passing zone markings should be placed on stopped approaches to intersections to prohibit passing for the last five seconds of travel distance at the 85th-percentile speed (when speed data is available), or the posted or statutory speed limit. See Table 3B-100.*

Table 3B-100. Minimum Distances for Marking No-Passing and Passing Zones

Speed (MPH)	Minimum Passing Sight Distance and Minimum Length of Passing Zone (ft)	Minimum No-Passing Zone on Stopped Approaches to Intersections (ft)
15	400	110
20	400	145
25	450	185
30	500	220
35	550	255
40	600	295
45	700	330
50	800	365
55	900	405
60	1,000	440
65	1,100	480
70	1,200	515

Section 3B.03 Other Yellow Longitudinal Pavement Markings

Guidance:

- 04 White two-way left-turn lane-use arrows (see Figure 3B-7), should be used in conjunction with the longitudinal two-way left-turn markings at the locations described in Section 3B.20.
- 05 Signs should be used in conjunction with the two-way left turn markings (see Section 2B.24).
- 05A Two-way left-turn lane markings should be broken at intersections with roads classified as collectors or arterials or with other high volume roads.

Section 3B.18 Crosswalk Markings

Standard:

- 03A Crosswalk markings shall be placed at the following locations:
 - A. At officially designated school crossings, and
 - B. At intersections controlled by traffic signals where pedestrian phases are used.
- 04 When crosswalk lines are used, they shall consist of solid white lines that mark the crosswalk. They shall **not be less than 6 inches or greater than 24 inches** in width.

Guidance:

- 05 ~~If transverse lines are used to mark a crosswalk, the gap between the lines should not be less than 6 feet. If diagonal or longitudinal lines are used without transverse lines to mark a crosswalk, the crosswalk should be not less than 6 feet wide. Marked crosswalks should not be less than 10 feet from inside edge to inside edge of transverse crosswalk lines or from outside edge to outside edge of longitudinal crosswalk lines.~~
- 06 ~~Crosswalk lines, if used on both sides of the crosswalk, should extend across the full width of pavement or to the edge of the intersecting crosswalk to discourage diagonal walking between crosswalks (see Figures 3B-17 and 3B-19).~~
- 07 ~~At locations controlled by traffic control signals or on approaches controlled by STOP or YIELD signs, crosswalk lines should be installed where engineering judgment indicates they are needed to direct pedestrians to the proper crossing path(s).~~
- 08 ~~Crosswalk lines should not be used indiscriminately. An engineering study should be performed before a marked crosswalk is installed at a location away from a traffic control signal or an approach controlled by a STOP or YIELD sign. The engineering study should consider the number of lanes, the presence of a median, the distance from adjacent signalized intersections, the pedestrian volumes and delays, the average daily traffic (ADT), the posted or statutory speed limit or 85th-percentile speed, the geometry of the location, the possible consolidation of multiple crossing points, the availability of street lighting, and other appropriate factors.~~
- 09 ~~New marked crosswalks alone, without other measures designed to reduce traffic speeds, shorten crossing distances, enhance driver awareness of the crossing, and/or provide active warning of pedestrian presence, should not be installed across uncontrolled roadways where the speed limit exceeds 40 mph and either:
 - A. The roadway has four or more lanes of travel without a raised median or pedestrian refuge island and an ADT of 12,000 vehicles per day or greater; or
 - B. The roadway has four or more lanes of travel with a raised median or pedestrian refuge island and an ADT of 15,000 vehicles per day or greater.~~
- 09A Where crosswalks are marked on approaches controlled by traffic signals or stop signs, transverse crosswalk lines should be used.

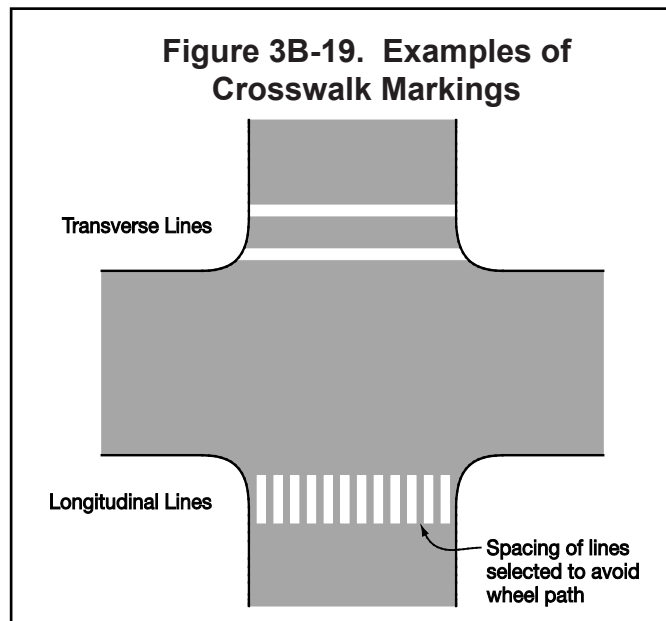

- 09B *Where crosswalks are marked on uncontrolled approaches or at midblock locations, longitudinal crosswalk lines should be used.*
- 09C *Decisions to mark crosswalks on uncontrolled approaches or at midblock locations should be made in accordance with Table 3B-101.*
- 09D *Crosswalks at intersections should be located as shown in Alaska Standard Drawings Manual, Standard Drawing T-23.*

Table 3B-101. Recommended Practice for Crosswalk Marking on Uncontrolled Approaches or at Midblock Locations

No of Lanes	Raised Median?	Vehicle ADT													
		<9,000				>9,000 to 12000				>12,000 to 15,000				>15,000	
		Speed Limit (MPH)													
		<30	35	40	>45	<30	35	40	>45	<30	35	>40	<30	35	>40
2	No	C	C	M	N	C	C	M	N	C	C	N	C	M	N
3	No	C	C	M	N	C	M	M	N	M	M	N	M	N	N
>4	Yes	C	C	M	N	C	M	N	N	M	M	N	N	N	N
>4	No	C	M	N	N	M	M	N	N	N	N	N	N	N	N

Source: FHWA-RD-01-075, Safety Effects of Marked vs. Unmarked Crosswalks at Uncontrolled Locations, 2002

- C** Candidate sites for marked crosswalks. Before marking a crosswalk, the site should be studied to ensure it is suitable. The study may include a review of pedestrian volumes, available gaps, sight distance (see Note 1), vehicle mix, pedestrian mix, distance to adjacent crossings (see Note 2), etc. Crosswalks should not be installed at locations with fewer than 20 pedestrian crossings per peak hour (or 15 for elderly and/or child pedestrians).
- M** Marginal candidate sites for marked crosswalks: Pedestrian accident risk may increase if crosswalks are marked. If pedestrian improvements are necessary, other options should be explored before marking crosswalks.
- N** Crosswalks should not be installed at these locations.

Notes: 1. Marked crosswalks should not be installed on uncontrolled approaches or at midblock locations where visibility distance of pedestrians or the crosswalk would be less than the "Stopping Sight Distance for Design" given in the latest version of the AASHTO A Policy on Geometric Design of Highways and Streets. Desirably, crosswalks would only be installed where there is sufficient sight distance to allow pedestrians to cross the road without conflicting with vehicles continuing at the 85th-percentile speed, assuming the pedestrian starts walking at the moment the vehicle comes into sight. Pedestrian crossing time should be computed in accordance with the procedure for determining adequate gaps given in the Institute of Transportation Engineers Traffic Engineering Handbook (page 78 in the 4th Edition).

2. Crosswalks should not be installed on uncontrolled approaches or at midblock locations where they will encourage pedestrians to divert from nearby signalized or grade-separated pedestrian crossings.

Support:

12 Section 3B.16 contains information regarding placement of stop line markings near crosswalk markings.

Option:

13 ~~When diagonal or longitudinal lines are used to mark a crosswalk, the transverse crosswalk lines may be omitted. This type of marking may be used at locations where substantial numbers of pedestrians cross without any other traffic control device, at locations where physical conditions are such that added visibility of the crosswalk is desired, or at places where a pedestrian crosswalk might not be expected.~~

13A For added visibility, transverse crosswalk lines may be placed on the outside edge of longitudinal crosswalk lines.

13B Longitudinal crosswalk lines may be installed with gaps in the rungs, as shown in Figure 3B-100, to allow pedestrians to walk on an unpainted surface.

~~44 For added visibility, the area of the crosswalk may be marked with white diagonal lines at a 45-degree angle to the line of the crosswalk or with white longitudinal lines parallel to traffic flow as shown in Figure 3B-19.~~

Guidance:

~~45 If used, the diagonal or longitudinal lines should be 12 to 24 inches wide and separated by gaps of 12 to 60 inches. The design of the lines and gaps should avoid the wheel paths if possible, and the gap between the lines should not exceed 2.5 times the width of the diagonal or longitudinal lines.~~

15A If used, the longitudinal lines should be 24 to 36 inches wide and spaced 24 to 36 inches apart. The design of the lines and gaps should avoid wheel paths if possible.

Standard:

15B **On-street parking shall not be marked for at least 20 feet on either side of a crosswalk (13 AAC 02.340).**

Guidance:

15C Additional parking prohibitions should be considered adjacent to crosswalks if engineering judgment indicates additional sight distance would be desirable.

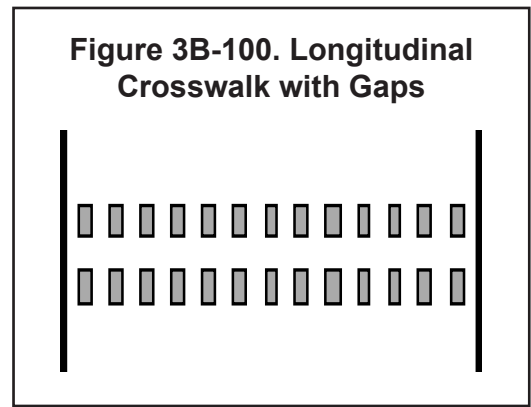

Section 3B.20 Pavement Word, Symbol, and Arrow Markings

Option:

37 The wrong-way arrow markings shown in Drawing D in Figure 3B-24 may be placed near the downstream terminus of a ramp as shown in Figures 2B-18 and 2B-19, or at other locations where lane-use arrows are not appropriate, to indicate the correct direction of traffic flow and to discourage drivers from traveling in the wrong direction.

Support:

37A Wrong-way arrows are for situations where ramp travel direction is not made obvious by the layout of the ramp intersection or merge.

Section 3B.100 Markings for Climbing and Passing Lanes

[This is a new section. There is no corresponding section in the MUTCD.]

Support:

01 See Figure 2B-100 for pavement marking layout for climbing and passing lanes.

CHAPTER 3F. DELINEATORS

Section 3F.03 Delineator Application

Standard:

- 01 **The color of delineators shall comply with the color of edge lines stipulated in Section 3B.06.**
- 02 **A series of single delineators shall be provided on the right-hand side of freeways and expressways and on at least one side of interchange ramps, except when either Condition A or Condition B is met, as follows:**
- A. On tangent sections of freeways and expressways when both of the following conditions are met:**
 - 1. Raised pavement markers are used continuously on lane lines throughout all curves and on all tangents to supplement pavement markings, and**
 - 2. Roadside delineators are used to lead into all curves.**
 - C. On sections of roadways where continuous lighting is in operation between interchanges.**
- 02A **Delineators shall be installed in accordance with Table 3F-100.**

Option:

- 02B Delineators may also be used for applications not covered by the table, including safety emphasis areas. See Section 3F of the MUTCD for additional information on the application of delineators.

Guidance:

- 02C *When used, snow pole delineators should be constructed in accordance with Figure 3F-100 and Figure 3F-101.*

Option:

- 02D Snow poles may be installed in three layout patterns: opposite, one-sided, or staggered.
- A. Opposite Layout: poles are placed on both shoulders across from each other.
 - B. One-sided Layout: poles are placed on one shoulder.
 - C. Staggered Layout: poles are placed on alternate shoulders.

Table 3F-100. Delineator Application

Application	Required/ Optional	Delineator- Type	Spacing		Offset from Edge of Pvmt	Post Material	Notes
			Tangent	Curves <40 MPH			
Right side of Freeways and Expressways, and one side of interchange ramps	Required except when exempting conditions of MUTCD Section 3F.03 are met	See MUTCD Section 3F.02	See MUTCD Section 3F.04	See MUTCD Section 3F.04	8'	Crash-worthy support (NCHRP 350 or MASH)	Red reflectors should be placed on the back of delineators on one-way roads.
Along acceleration or deceleration lanes and at median cross-overs	Optional	See MUTCD Section 3F.02 (double height reflector)	See MUTCD Section 3F.04	See MUTCD Section 3F.04	2' – 8'	Crash-worthy support (NCHRP 350 or MASH)	Delineators provide better guidance to motorists when they are placed close (2') to the edge of pavement. However, offsets nearer 8' make road maintenance easier. Maintenance workers should be consulted when determining delineator offsets.
Areas with poor winter visibility	Optional	Shoulder snow pole (see Figure 3F-100)	200' max.	100' max.	2' - 8'	Crash-worthy support (NCHRP 350 or MASH)	
Areas with poor winter visibility and extremely heavy snow accumulations	Optional	Overhead snow pole (see Figure 3F-101)	200' max.	100' max.	12'	Steel pipe, concrete foundation, breakaway base	
Guardrail End Terminals (GETs)	Required On state highways	Terminal Marker Posts	On every GET	On every GET	At GET	Two flexible delineators, one at each end of GET	Each delineator should have at least a 3" x 6" area of reflective sheeting with color matching edgeline.

Figure 3F-100. Shoulder Snow Pole

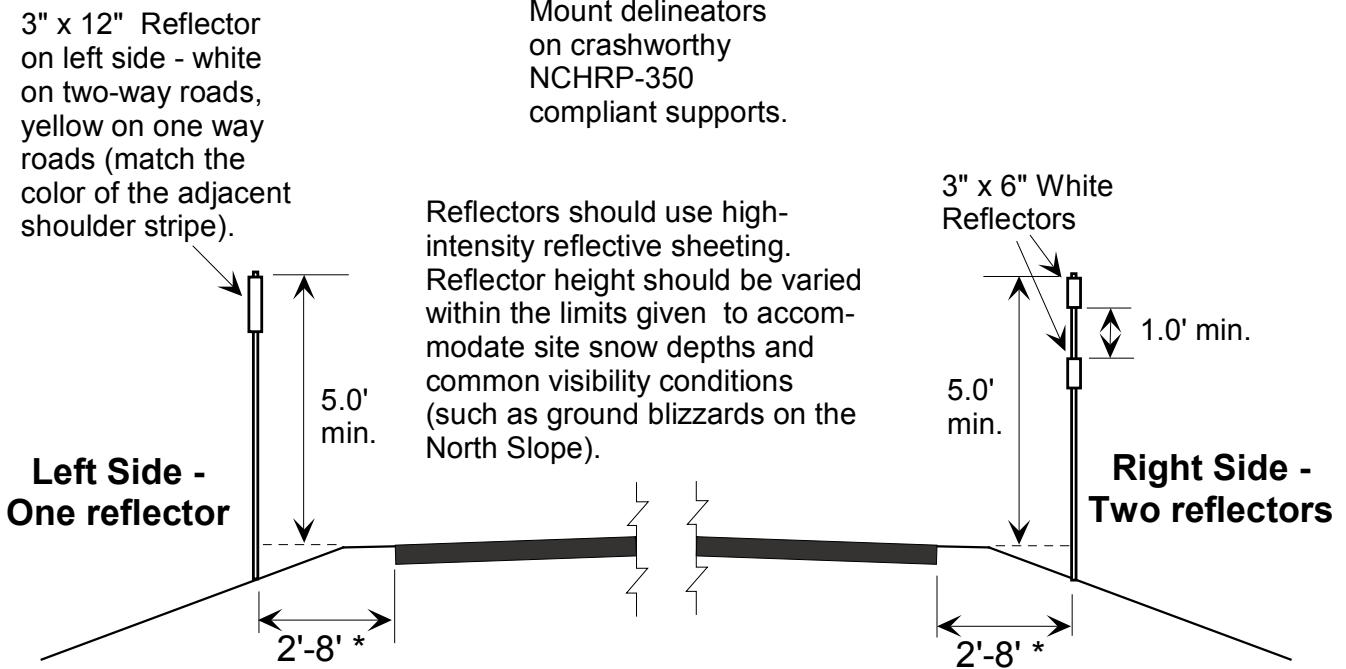

* Delineators provide better guidance to motorists when they are placed close (2') to the edge of pavement. However, offsets nearer 8' makes road maintenance easier. Maintenance workers should be consulted when determining delineator offsets.

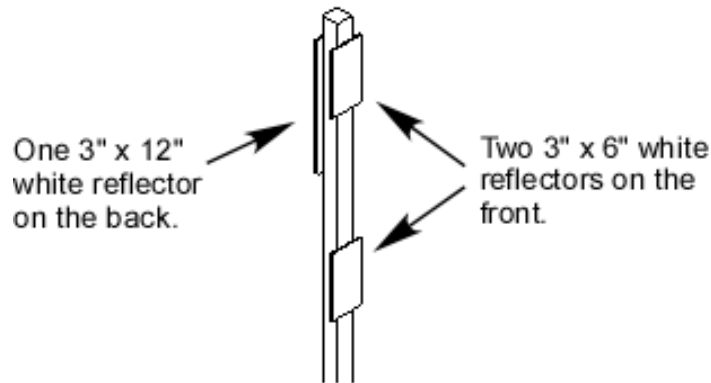

Typical right-shoulder Installation on a two-lane, two-way road.

Figure 3F-101. Overhead Snow Pole

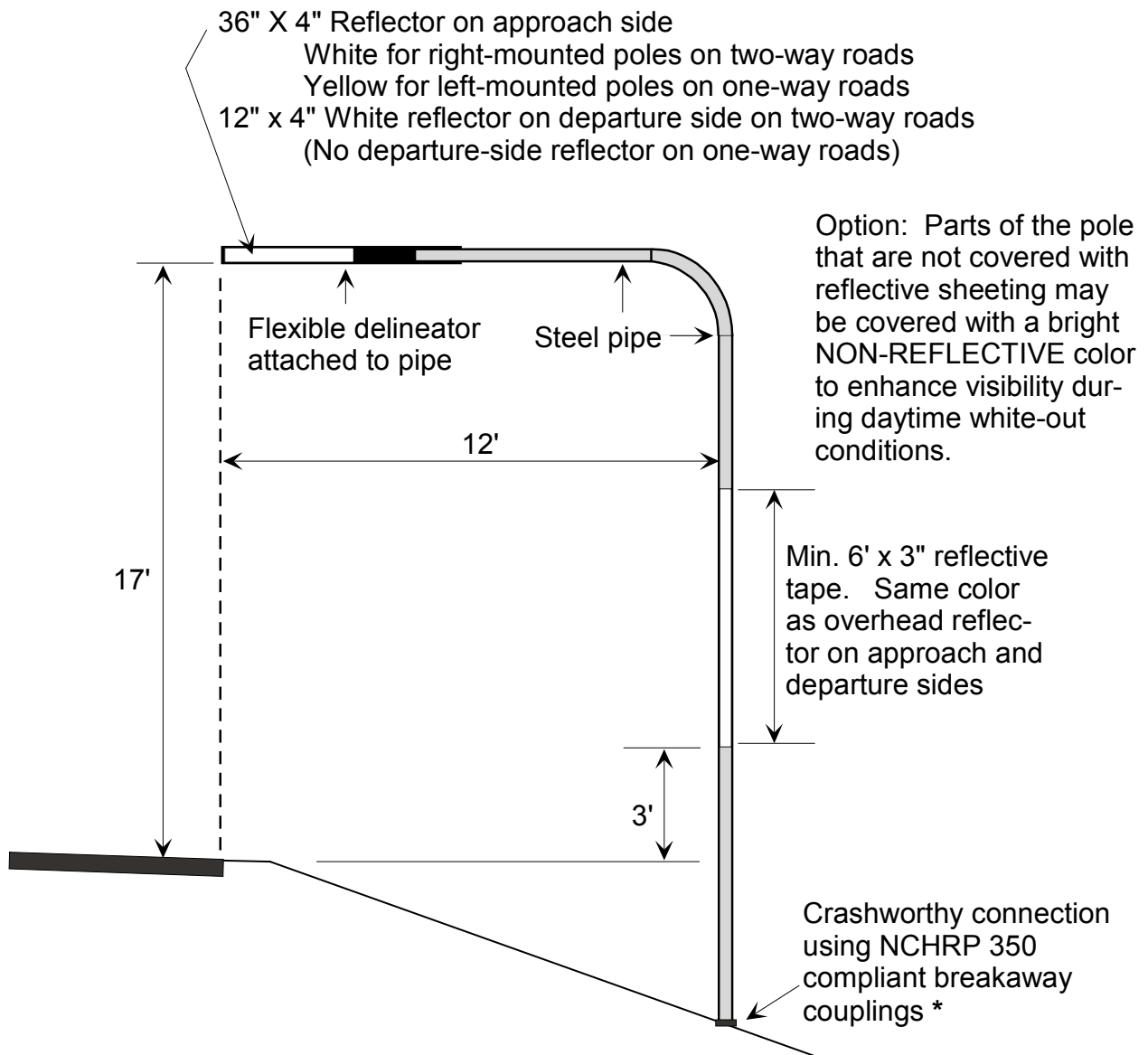

* Where installed 4 feet or more behind the near edge of the nearest guardrail post and where it is not possible for a vehicle to penetrate a guardrail end terminal and strike the support, the breakaway couplings may be omitted.

(This page left intentionally blank.)

PART 4

HIGHWAY TRAFFIC SIGNALS

CHAPTER 4D. TRAFFIC CONTROL SIGNAL FEATURES

Section 4D.02 Responsibility for Operation and Maintenance

Guidance:

- 01 *Prior to installing any traffic control signal, the responsibility for the maintenance of the signal and all of the appurtenances, hardware, software, and the timing plan(s) should be clearly established. The responsible agency should provide for the maintenance of the traffic control signal and all of its appurtenances in a competent manner.*
- 02 *To this end the agency should:*
 - A. *Keep every controller assembly in effective operation in accordance with its predetermined timing schedule; check the operation of the controller assembly frequently enough to verify that it is operating in accordance with the predetermined timing schedule; and establish a policy to maintain a record of all timing changes and that only authorized persons are permitted to make timing changes;*
 - B. *Clean the optical system of the signal sections and replace the light sources as frequently as experience proves necessary;*
 - C. *Clean and service equipment and other appurtenances as frequently as experience proves necessary;*
 - D. *Consider alternate operation of the traffic control signal during a period of failure, using flashing mode or manual control, or manual traffic direction by proper authorities as might be required by traffic volumes or congestion, or by erecting other traffic control devices;*
 - E. *Have properly skilled maintenance personnel available without undue delay for all signal malfunctions and signal indication failures;*
 - F. *Provide spare equipment to minimize the interruption of traffic control signal operation as a result of equipment failure;*
 - G. *Provide for the availability of properly skilled maintenance personnel for the repair of all components; and*
 - H. *Maintain the appearance of the signal displays and equipment.*
 - I. *Keep a signal record in each signal cabinet along with a phasing schematic and wiring diagram. The signal record or log should contain the following:*
 1. *Current or intersection-specific default signal timing, which can be kept in printed form or in non-volatile electronic memory. When the signal controller is connected to a central computer that can upload and download timings, the signal timing can be stored at the central computer.*
 2. *Date and time of changes or maintenance operations.*
 3. *Initials of person changing timing or performing maintenance.*
 4. *Type of maintenance operation and characteristics of equipment failure or faulty operation evident before repair.*

Section 4D.04 Meaning of Vehicular Signal Indications

Standard:

- 03 **The following meanings shall be given to highway traffic signal indications for vehicles and pedestrians:**
 - A. **Steady red signal indications shall have the following meanings:**
 1. **Vehicular traffic facing a steady CIRCULAR RED signal indication, unless entering the intersection to make another movement permitted by another signal indication, shall stop at a clearly marked stop line; but if there is no stop line, traffic shall stop before entering the crosswalk on the near side of the intersection; or if there is no crosswalk, then before entering the intersection; and shall remain stopped until a signal indication to proceed is displayed, or as provided**

below.

Except when a traffic control device is in place prohibiting a turn on red or a steady RED ARROW signal indication is displayed, vehicular traffic facing a steady CIRCULAR RED signal indication is permitted to enter the intersection to turn right, or to turn left from a one-way street into a one-way street, after stopping. The right to proceed with the turn shall be subject to the rules applicable after making a stop at a STOP sign.

2. Vehicular traffic facing a steady RED ARROW signal indication shall not enter the intersection to make the movement indicated by the arrow and, unless entering the intersection to make another movement permitted by another signal indication, shall stop at a clearly marked stop line; but if there is no stop line, before entering the crosswalk on the near side of the intersection; or if there is no crosswalk, then before entering the intersection; and shall remain stopped until a signal indication or other traffic control device permitting the movement indicated by such RED ARROW is displayed.

~~When a traffic control device is in place permitting a turn on a steady RED ARROW signal indication, vehicular traffic facing a steady RED ARROW signal indication is permitted to enter the intersection to make the movement indicated by the arrow signal indication, after stopping. The right to proceed with the turn shall be limited to the direction indicated by the arrow and shall be subject to the rules applicable after making a stop at a STOP sign.~~

3. Unless otherwise directed by a pedestrian signal indication or other traffic control device, pedestrians facing a steady CIRCULAR RED or steady RED ARROW signal indication shall not enter the roadway.

Section 4D.05 Application of Steady Signal Indications

Standard:

- 01 When a traffic control signal is being operated in a steady (stop-and-go) mode, at least one indication in each signal face shall be displayed at any given time.
- 02 A signal face(s) that controls a particular vehicular movement during any interval of a cycle shall control that same movement during all intervals of the cycle.
- 03 Steady signal indications shall be applied as follows:

B. A steady CIRCULAR YELLOW signal indication:

4. Shall not be displayed to an approach from which drivers are turning left permissively or making a U-turn to the left permissively unless one of the following conditions exists:

(a) A steady CIRCULAR YELLOW signal indication is also simultaneously being displayed to the opposing approach;

~~(b) An engineering study has determined that, because of unique intersection conditions, the condition described in Item (a) cannot reasonably be implemented without causing significant operational or safety problems and that the volume of impacted left-turning or U-turning traffic is relatively low, and those left-turning or U-turning drivers are advised that a steady CIRCULAR YELLOW signal indication is not simultaneously being displayed to the opposing traffic if this operation occurs continuously by the installation near the left-most signal head of a W25-1 sign (see Section 2C.48) with the legend ONCOMING TRAFFIC HAS EXTENDED GREEN; or~~

~~(c) Drivers are advised of the operation if it occurs only occasionally, such as during a preemption sequence, by the installation near the left-most signal head of a W25-2 sign (see Section 2C.48) with the legend ONCOMING TRAFFIC MAY HAVE EXTENDED GREEN.~~

E. A steady YELLOW ARROW signal indication:

5. Shall not be displayed to terminate a flashing arrow signal indication on an approach from which drivers are turning left permissively or making a U-turn to the left permissively unless one of the following conditions exists:

(a) A steady CIRCULAR YELLOW signal indication is also simultaneously being displayed to

the opposing approach;

- ~~(b) An engineering study has determined that, because of unique intersection conditions, the condition described in Item (a) cannot reasonably be implemented without causing significant operational or safety problems and that the volume of impacted left-turning or U-turning traffic is relatively low, and those left-turning or U-turning drivers are advised that a steady CIRCULAR YELLOW signal indication is not simultaneously being displayed to the opposing traffic if this operation occurs continuously by the installation near the left-most signal head of a W25-1 sign (see Section 2C.48) with the legend ONCOMING TRAFFIC HAS EXTENDED GREEN; or~~
- ~~(c) Drivers are advised of the operation if it occurs only occasionally, such as during a preemption sequence, by the installation near the left-most signal head of a W25-2 sign (see Section 2C.48) with the legend ONCOMING TRAFFIC MAY HAVE EXTENDED GREEN.~~

Section 4D.11 Number of Signal Faces on an Approach

Standard:

⁰¹ The signal faces for each approach to an intersection or a midblock location shall be provided as follows:

- A. If a signalized through movement exists on an approach, a minimum of two primary signal faces shall be provided for the through movement. If a signalized through movement does not exist on an approach, a minimum of two primary signal faces shall be provided for the signalized turning movement that is considered to be the major movement from the approach (also see Section 4D.25)
 - One of the primary signal faces for the through movement shall be a side-mounted or post-mounted signal face on the far side of the cross street and to the right of traffic approaching the signal (far-right position). The side-mounted or post-mounted signal face shall be supplemented by the number of overhead through signal faces as shown in Table 4D-100.
 - All primary signal faces shall be located on the far side of the intersection.
 - On a one-way street that is three or more lanes wide, an additional post-mounted signal face shall be installed on the far left side of the intersection.
- B. The primary signal face for a protected left-turn phase shall be located:
 - 1. Overhead approximately over the center of a single left-turn lane.
 - 2. Overhead approximately over the extension of the lane line between dual left-turn lanes.The shared signal face for a protected/permissive left-turn phase shall be located:
 - 1. Overhead approximately over the lane line separating the turn lane from the adjacent through lane where an exclusive turn lane is provided.
 - 2. Overhead approximately over the center of the left-most lane or approximately over the lane line separating the left-most two lanes where an exclusive turn lane is not provided.The primary signal face for a protected/permissive left-turn signal indication displaying a flashing YELLOW ARROW shall be located overhead approximately over the center of the left-turn lane.
 - See Sections 4D.17 through 4D.20 for left-turn (and U-turn to the left) signal faces.
- C. The primary signal face for a right-turn movement with exclusive right-turn phasing that overlaps the through-traffic phase shall be side-mounted on the far right side.
 - See Sections 4D.21 through 4D.24 for right-turn (and U-turn to the right) signal faces.

Option:

- ⁰² Where a movement (or a certain lane or lanes) at the intersection never conflicts with any other signalized vehicular or pedestrian movement, a continuously-displayed single-section GREEN ARROW signal indication may be used to inform road users that the movement is free-flow and does not need to stop.
- ^{02A} In urban centers and other locations where the far-right position signal would be obscured or outside the cone of vision as shown in Figure 4D-4 of the 2009 MUTCD, an overhead signal face may be substituted.

^{02B} If the mast arm of an existing signal installation is not long enough to permit installation of a signal face displaying a flashing YELLOW ARROW over the center of the left-turn lane, the signal face may be located within an extension of the lane lines and as close to the center as possible.

Guidance:

⁰³ *If two or more left-turn lanes are provided for a separately controlled protected only mode left-turn movement, or if a left-turn movement represents the major movement from an approach, two or more primary left-turn signal faces should be provided.*

⁰⁴ *If two or more right-turn lanes are provided for a separately controlled right-turn movement, or if a right-turn movement represents the major movement from an approach, two or more primary right-turn signal faces should be provided.*

^{04A} *A supplemental far-side left-turn signal face should be provided where there is protected or protected/permissive left-turn phasing. The signal face should consist of a three-section signal face (all arrows) for a protected-only left-turn movement, a four-section signal face for a protected/permissive left-turn movement with a flashing left-turn YELLOW ARROW, or a five-section vertically arranged signal face for other protected/permissive left-turn phasing.*

Guidance:

~~⁰⁷ If the posted or statutory speed limit or the 85th-percentile speed on an approach to a signalized location is 45 mph or higher, signal faces should be provided as follows for all new or reconstructed signal installations (see Figure 4D-3):~~

- ~~A. The minimum number and location of primary (non-supplemental) signal faces for through traffic should be provided in accordance with Table 4D-1.~~
- ~~B. If the number of overhead primary signal faces for through traffic is equal to the number of through lanes on an approach, one overhead signal face should be located approximately over the center of each through lane.~~
- ~~C. Except for shared left-turn and right-turn signal faces, any primary signal face required by Sections 4D.17 through 4D.25 for an exclusive turn lane should be located overhead approximately over the center of each exclusive turn lane.~~
- ~~D. All primary signal faces should be located on the far side of the intersection.~~
- ~~E. In addition to the primary signal faces, one or more supplemental pole-mounted or overhead signal faces should be considered to provide added visibility for approaching traffic that is traveling behind large vehicles.~~
- ~~F. All signal faces should have backplates.~~

~~⁰⁸ This layout of signal faces should also be considered for any major urban or suburban arterial street with four or more lanes and for other approaches with speeds of less than 45 mph.~~

[Delete Table 4D-1.]

[Delete Figure 4D-3.]

[Delete Figure 4D-6 through 4D-12, 4D-15, and 4D-20. Figure 4D-100 shows typical signal head locations.]

Table 4D-100. Recommended Minimum Number of Through Overhead Signals

Number of Through Approach Lanes	Type of Left-Turn Phasing			
	Permissive, Protected Only, or Protected/Permissive with Flashing Yellow Arrow		Protected/Permissive Shared Face (Not Flashing Yellow Arrow)	
	HEADS ^A	SPACING ^{B,C}	HEADS ^A	SPACING ^{B,C}
1	1	--	0 ^D	--
2	1	--	1	12'
3	2	12'	2	12'
4 or more	3	12'	--	--

A. Minimum number of heads centered over the through approach

B. Approximate spacing between the overhead signals (based on 12' lane width)

C. If the number of overhead signal faces for through traffic is equal to the number of through lanes on an approach, one overhead signal face should be located approximately over the center of each through lane.

D. Overhead indication is provided by the protected/permissive signal head

Table 4D-100 shows the recommended minimum number of through overhead signals for various intersection configurations. Table 4D-100 is applicable to new, rehabilitated, or reconstructed signals (3R and 4R projects).

NOTE: Near-side heads (not shown) may be needed on wide intersections.

Figure 4D-100. Recommended Minimum Signal Head Location

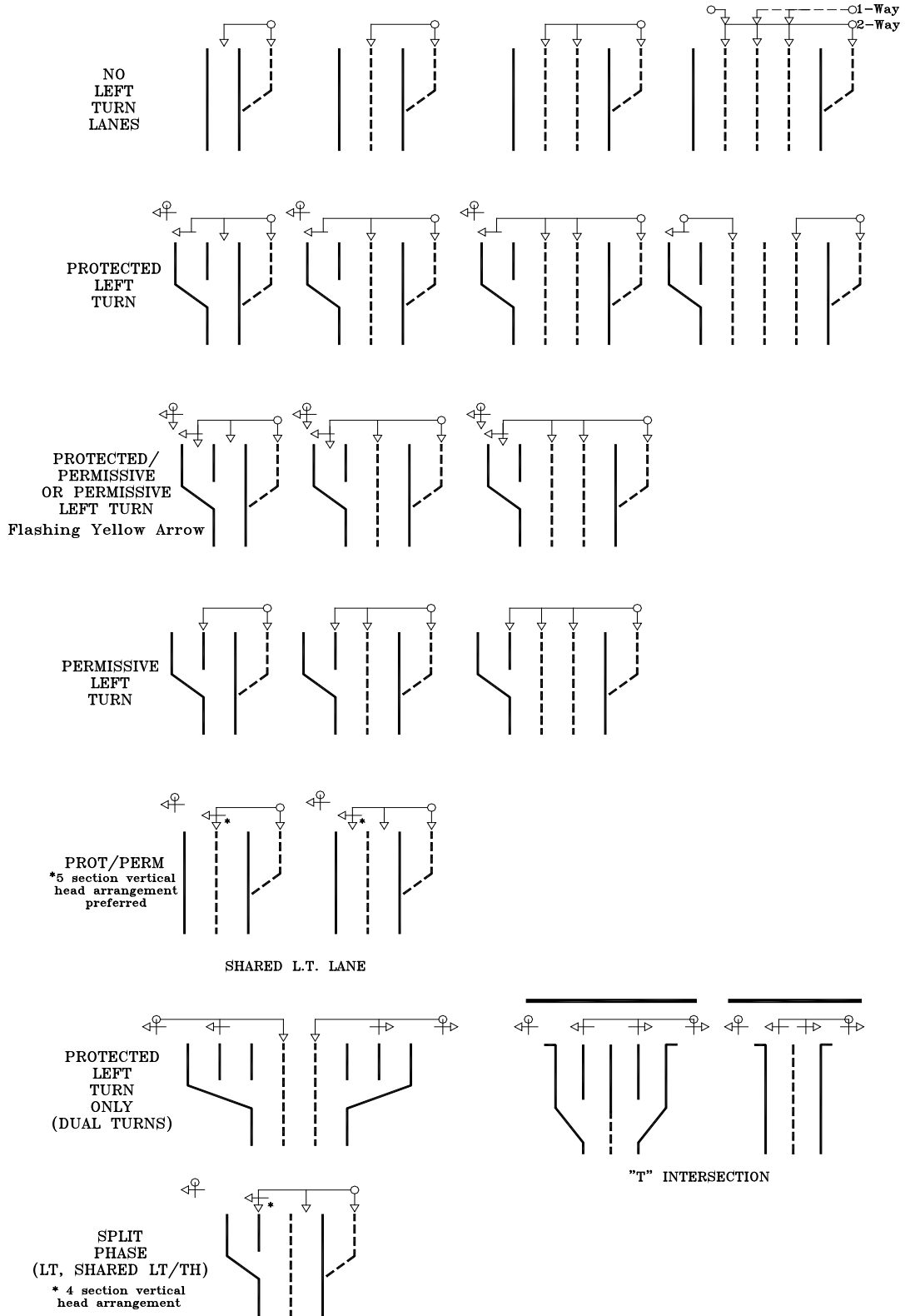

Section 4D.15 Mounting Height of Signal Faces

Standard:

- ⁰¹ The top of the signal housing of a vehicular signal face located over any portion of a highway that can be used by motor vehicles shall not be more than 25.6 feet above the pavement.
- ⁰² For viewing distances between 40 and 53 feet from the stop line, the maximum mounting height to the top of the signal housing shall be as shown in Figure 4D-5.
- ⁰³ The bottom of the signal housing and any related attachments to a vehicular signal face located over any portion of a highway that can be used by motor vehicles shall be at least ~~15~~ 17.5 feet above the pavement.
- ⁰⁴ The bottom of the signal housing (including brackets) of a vehicular signal face that is vertically arranged and not located over a roadway:
- A. Shall be a minimum of ~~8~~ 10 feet and a maximum of 19 feet above the sidewalk or, if there is no sidewalk, above the pavement grade at the center of the roadway.
 - B. Shall be a minimum of ~~4.5~~ 7 feet and a maximum of 19 feet above the median island grade of a center median island if located on the near side of the intersection.
- ⁰⁵ The bottom of the signal housing (including brackets) of a vehicular signal face that is horizontally arranged and not located over a roadway:
- A. Shall be a minimum of ~~8~~ 10 feet and a maximum of 22 feet above the sidewalk or, if there is no sidewalk, above the pavement grade at the center of the roadway.
 - B. Shall be a minimum of ~~4.5~~ 7 feet and a maximum of 22 feet above the median island grade of a center median island if located on the near side of the intersection.

Section 4D.17 Signal Indications for Left-Turn Movements – General

Standard:

- ^{13A} If a single exclusive left-turn lane is provided on an approach and operated in either permissive only left-turn mode or protected/permissive left-turn mode, the left-turn movement shall be controlled by a flashing left-turn YELLOW ARROW. This standard applies to:
- A. All new traffic signal installations.
 - B. Existing traffic signal installations where new left-turn signal faces are installed.
- ^{13B} A flashing left-turn YELLOW ARROW shall not be terminated before the CIRCULAR GREEN indication for the opposing through movement is terminated.

Guidance:

- ^{13C} *At least two signal faces should be provided for a left-turn movement controlled by a flashing left-turn YELLOW ARROW indication.*

Option:

- ^{13D} Existing shared signal faces for permissive-only or protected/permissive mode left-turn movements may be replaced by a new shared signal face.
- ^{13E} Permissive-only mode left-turn movements on minor side streets may be controlled by a shared signal face displaying a CIRCULAR GREEN signal indication.
- ^{13F} A shared signal face for permissive-only or protected/permissive mode left-turn movements may be used for existing signal installations under the following conditions:
- A. The existing signal mast arm is not long enough to position a signal face over the extension of the left-turn lane or engineering judgment indicates installation somewhere other than the center of the left-turn lane would cause driver confusion.
 - B. The existing signal controller equipment is not compatible with flashing left-turn YELLOW ARROW operation.
 - C. The signal pole assembly or foundation is not capable of supporting the load that would result from positioning a signal face over the extension of the left-turn lane.

Guidance:

^{13G} Where the existing signal mast arm, signal pole assembly, pole foundation, or signal controller equipment does not permit the use of flashing left-turn YELLOW ARROW operation, replacement of the limiting components should be considered.

Section 4D.18 Signal Indications for Permissive Only Mode Left-Turn Movements

Standard:

- ⁰¹ If a shared signal face is provided for a permissive only mode left turn, it shall meet the following requirements (see Figure ~~4D-6~~ 4D-100):
- A. It shall be capable of displaying the following signal indications: steady CIRCULAR RED, steady CIRCULAR YELLOW, and CIRCULAR GREEN. Only one of the three indications shall be displayed at any given time.
 - B. During the permissive left-turn movement, a CIRCULAR GREEN signal indication shall be displayed.
 - C. A permissive only shared signal face, regardless of where it is positioned and regardless of how many adjacent through signal faces are provided, shall always simultaneously display the same color of circular indication that the adjacent through signal face or faces display.
 - D. If the permissive only mode is not the only left-turn mode used for the approach, the signal face shall be the same shared signal face that is used for the protected/permissive mode (see Section 4D.20) except that the left-turn GREEN ARROW and left-turn YELLOW ARROW signal indications shall not be displayed when operating in the permissive only mode.
- ⁰² If a separate left-turn signal face is being operated in a permissive only left-turn mode, a CIRCULAR GREEN signal indication shall not be used in that face.
- ⁰³ If a separate left-turn signal face is being operated in a permissive only left-turn mode and a flashing left-turn YELLOW ARROW signal indication is provided, it shall meet the following requirements (see Figure ~~4D-7~~ 4D-100):
- A. It shall be capable of displaying the following signal indications: steady left-turn RED ARROW, steady left-turn YELLOW ARROW, and flashing left-turn YELLOW ARROW. Only one of the three indications shall be displayed at any given time.
 - B. During the permissive left-turn movement, a flashing left-turn YELLOW ARROW signal indication shall be displayed.
 - C. A steady left-turn YELLOW ARROW signal indication shall be displayed following the flashing left-turn YELLOW ARROW signal indication.
 - D. It shall be permitted to display a flashing left-turn YELLOW ARROW signal indication for a permissive left-turn movement while the signal faces for the adjacent through movement display steady CIRCULAR RED signal indications and the opposing left-turn signal faces display left-turn GREEN ARROW signal indications for a protected left-turn movement.
 - E. During steady mode (stop-and-go) operation, the signal section that displays the steady left-turn YELLOW ARROW signal indication during change intervals shall not be used to display the flashing left-turn YELLOW ARROW signal indication for permissive left turns.
 - F. During flashing mode operation (see Section 4D.30), the display of a flashing left-turn YELLOW ARROW signal indication shall be only from the signal section that displays a steady left-turn YELLOW ARROW signal indication during steady mode (stop-and-go) operation.
 - G. If the permissive only mode is not the only left-turn mode used for the approach, the signal face shall be the same separate left-turn signal face with a flashing YELLOW ARROW signal indication that is used for the protected/permissive mode (see Section 4D.20) except that the left-turn GREEN ARROW signal indication shall not be displayed when operating in the permissive only mode.

Option:

- ~~⁰⁴ A separate left-turn signal face with a flashing left-turn RED ARROW signal indication during the permissive left-turn movement may be used for unusual geometric conditions, such as wide medians with offset left-turn lanes, but only when an engineering study determines that each and every vehicle must successively come to a full stop before making a permissive left turn.~~

Standard:

~~05~~—If a separate left-turn signal face is being operated in a permissive only left-turn mode and a flashing left-turn RED ARROW signal indication is provided, it shall meet the following requirements (see Figure 4D-8):

- ~~A. It shall be capable of displaying the following signal indications: steady or flashing left-turn RED ARROW, steady left-turn YELLOW ARROW, and left-turn GREEN ARROW. Only one of the three indications shall be displayed at any given time. The GREEN ARROW indication is required in order to provide a three-section signal face, but shall not be displayed during the permissive only mode.~~
- ~~B. During the permissive left-turn movement, a flashing left-turn RED ARROW signal indication shall be displayed, thus indicating that each and every vehicle must successively come to a full stop before making a permissive left turn.~~
- ~~C. A steady left-turn YELLOW ARROW signal indication shall be displayed following the flashing left-turn RED ARROW signal indication.~~
- ~~D. It shall be permitted to display a flashing left-turn RED ARROW signal indication for a permissive left-turn movement while the signal faces for the adjacent through movement display steady CIRCULAR RED signal indications and the opposing left-turn signal faces display left-turn GREEN ARROW signal indications for a protected left-turn movement.~~
- ~~E. A supplementary sign shall not be required. If used, it shall be a LEFT TURN YIELD ON FLASHING RED ARROW AFTER STOP (R10-27) sign (see Figure 2B-27).~~

Option:

~~06~~—The requirements of Item A in Paragraph 5 may be met by a vertically-arranged signal face with a horizontal cluster of two left-turn RED ARROW signal indications, the left-most of which displays a steady indication and the right-most of which displays a flashing indication (see Figure 4D-8).

Section 4D.19 Signal Indications for Protected Only Mode Left-Turn Movements

Standard:

⁰¹ A shared signal face shall not be used for protected only mode left turns unless the CIRCULAR GREEN and left-turn GREEN ARROW signal indications always begin and terminate together. If a shared signal face is provided for a protected only mode left turn, it shall meet the following requirements (see Figure ~~4D-9~~ 4D-100):

- A. It shall be capable of displaying the following signal indications: steady CIRCULAR RED, steady CIRCULAR YELLOW, CIRCULAR GREEN, and left-turn GREEN ARROW. Only one of the three colors shall be displayed at any given time.
- B. During the protected left-turn movement, the shared signal face shall simultaneously display both a CIRCULAR GREEN signal indication and a left-turn GREEN ARROW signal indication.
- C. The shared signal face shall always simultaneously display the same color of circular indication that the adjacent through signal face or faces display.
- D. If the protected only mode is not the only left-turn mode used for the approach, the signal face shall be the same shared signal face that is used for the protected/permissive mode (see Section 4D.20).

Option:

⁰² A straight-through GREEN ARROW signal indication may be used instead of the CIRCULAR GREEN signal indication in Items A and B in Paragraph 1 on an approach where right turns are prohibited and a straight-through GREEN ARROW signal indication is also used instead of a CIRCULAR GREEN signal indication in the other signal face(s) for through traffic.

Standard:

⁰³ If a separate left-turn signal face is provided for a protected only mode left turn, it shall meet the following requirements (see Figure ~~4D-10~~ 4D-100):

- A. It shall be capable of displaying, the following signal indications: steady left-turn RED ARROW, steady left-turn YELLOW ARROW, and left-turn GREEN ARROW. Only one of the three indications shall be displayed at any given time. A signal instruction sign shall not be required with this set of signal indications. If used, it shall be a LEFT ON GREEN ARROW ONLY (R10-5) sign (see Figure 2B-27).
- B. During the protected left-turn movement, a left-turn GREEN ARROW signal indication shall be displayed.

- C. A steady left-turn YELLOW ARROW signal indication shall be displayed following the left-turn GREEN ARROW signal indication.
- D. If the protected only mode is not the only left-turn mode used for the approach, the signal face shall be the same separate left-turn signal face that is used for the protected/permissive mode (see Section 4D.20 and Figures 4D-8 and 4D-12 Figure 4D-100) except that the flashing left-turn YELLOW ARROW or flashing left-turn RED ARROW signal indication shall not be displayed when operating in the protected only mode.

Section 4D.20 Signal Indications for Protected/Permissive Mode Left-Turn Movements

Standard:

- ⁰¹ If a shared signal face is provided for a protected/permissive mode left turn, it shall meet the following requirements (see Figure ~~4D-11~~ 4D-100):

[Note: Items A-E are not modified by this ATMS and are omitted for brevity.]

- F. A supplementary sign shall not be required. If used, it shall be a LEFT TURN YIELD ON GREEN (symbolic circular green) (R10-12) sign (see Figure 2B-27) or R10-100 Left Turn ONLY ON GREEN (symbolic circular green) sign.

- ⁰² If a separate left-turn signal face is being operated in a protected/permissive left-turn mode, a CIRCULAR GREEN signal indication shall not be used in that face.

- ⁰³ If a separate left-turn signal face is being operated in a protected/permissive left-turn mode and a flashing left-turn yellow arrow signal indication is provided, it shall meet the following requirements (see Figure ~~4D-12~~ 4D-100):

[Note: Items A-B and D-J are not modified by this ATMS and are omitted for brevity.]

- C. A steady left-turn YELLOW ARROW and a steady left-turn RED ARROW signal indication shall be displayed following the left-turn GREEN ARROW signal indication. The duration of the steady left-turn RED ARROW signal indication shall be at least two seconds.

Standard:

- ~~⁰⁵ If a separate left-turn signal face is being operated in a protected/permissive left-turn mode and a flashing left-turn RED arrow signal indication is provided, it shall meet the following requirements (see Figure 4D-8):~~

- ~~A. It shall be capable of displaying the following signal indications: steady or flashing left-turn RED ARROW, steady left-turn YELLOW ARROW, and left-turn GREEN ARROW. Only one of the three indications shall be displayed at any given time.~~
- ~~B. During the protected left-turn movement, a left-turn GREEN ARROW signal indication shall be displayed.~~
- ~~C. A steady left-turn YELLOW ARROW signal indication shall be displayed following the left-turn GREEN ARROW signal indication.~~
- ~~D. During the permissive left-turn movement, a flashing left-turn RED ARROW signal indication shall be displayed.~~
- ~~E. A steady left-turn YELLOW ARROW signal indication shall be displayed following the flashing left-turn RED ARROW signal indication if the permissive left-turn movement is being terminated and the separate left-turn signal face will subsequently display a steady left-turn RED ARROW indication.~~
- ~~F. When a permissive left-turn movement is changing to a protected left-turn movement, a left-turn GREEN ARROW signal indication shall be displayed immediately upon the termination of the flashing left-turn RED ARROW signal indication. A steady left-turn YELLOW ARROW signal indication shall not be displayed between the display of the flashing left-turn RED ARROW signal indication and the display of the steady left-turn GREEN ARROW signal indication.~~
- ~~G. It shall be permitted to display a flashing left-turn RED ARROW signal indication for a permissive left-turn movement while the signal faces for the adjacent through movement display steady CIRCULAR RED signal indications and the opposing left-turn signal faces display left-turn GREEN ARROW signal indications for a protected left-turn movement.~~
- ~~H. A supplementary sign shall not be required. If used, it shall be a LEFT TURN YIELD ON FLASHING RED ARROW AFTER STOP (R10-27) sign (see Figure 2B-27).~~

Option:

~~06—The requirements of Item A in Paragraph 5 may be met by a vertically-arranged signal face with a horizontal cluster of two left-turn RED ARROW signal indications, the left-most of which displays a steady indication and the right-most of which displays a flashing indication (see Figure 4D-8).~~

Section 4D.22 Signal Indications for Permissive Only Mode Right-Turn Movements

Option:

~~04—When an engineering study determines that each and every vehicle must successively come to a full stop before making a permissive right turn, a separate right-turn signal face with a flashing right-turn RED ARROW signal indication during the permissive right-turn movement may be used.~~

Standard:

~~05—If a separate right-turn signal face is being operated in a permissive only right-turn mode and a flashing right-turn RED ARROW signal indication is provided, it shall meet the following requirements (see Figure 4D-15):~~

~~A. It shall be capable of displaying one of the following sets of signal indications:~~

- ~~1. Steady or flashing right-turn RED ARROW, steady right-turn YELLOW ARROW, and right-turn GREEN ARROW. Only one of the three indications shall be displayed at any given time. The GREEN ARROW indication is required in order to provide a three-section signal face, but shall not be displayed during permissive only mode.~~
- ~~2. Steady CIRCULAR RED on the left and steady right-turn RED ARROW on the right of the top position, steady right-turn YELLOW ARROW in the middle position, and right-turn GREEN ARROW in the bottom position. Only one of the four indications shall be displayed at any given time. The GREEN ARROW indication is required in order to provide three vertical positions, but shall not be displayed during permissive only mode. If the CIRCULAR RED signal indication is sometimes displayed when the signal faces for the adjacent through lane(s) are not displaying a CIRCULAR RED signal indication, a RIGHT TURN SIGNAL (R10-10R) sign (see Figure 2B-27) shall be used unless the CIRCULAR RED signal indication in the separate right-turn signal face is shielded, hooded, louvered, positioned, or designed such that it is not readily visible to drivers in the through lane(s).~~

~~B. During the permissive right-turn movement, a flashing right-turn RED ARROW signal indication shall be displayed, thus indicating that each and every vehicle must successively come to a full stop before making a permissive right turn.~~

~~C. A steady right-turn YELLOW ARROW signal indication shall be displayed following the flashing right-turn RED ARROW signal indication.~~

~~D. When the separate right-turn signal face is providing a message to stop and remain stopped, a steady right-turn RED ARROW signal indication shall be displayed if it is intended that right turns on red not be permitted (except when a traffic control device is in place permitting a turn on a steady RED ARROW signal indication) or a steady CIRCULAR RED signal indication shall be displayed if it is intended that right turns on red be permitted.~~

~~E. The display of a flashing right-turn RED ARROW signal indication for a permissive right-turn movement while the signal faces for the adjacent through movement display steady CIRCULAR RED signal indications and the opposing left-turn signal faces display left-turn GREEN ARROW signal indications for a protected left-turn movement shall be permitted.~~

~~F. A supplementary sign shall not be required. If used, it shall be a RIGHT TURN YIELD ON FLASHING RED ARROW AFTER STOP (R10-27) sign (see Figure 2B-27).~~

Option:

~~06—The requirements of Item A.1 in Paragraph 5 may be met by a vertically-arranged signal face with a horizontal cluster of two right-turn RED ARROW signal indications, the left-most of which displays a steady indication and the right-most of which displays a flashing indication (see Figure 4D-15).~~

Section 4D.23 Signal Indications for Protected Only Mode Right-Turn Movements

Standard:

~~03 If a separate right-turn signal face is provided for a protected only mode right turn, it shall meet the following requirements (see Figure 4D-17):~~

- A. It shall be capable of displaying one of the following sets of signal indications:
 1. Steady right-turn RED ARROW, steady right-turn YELLOW ARROW, and right-turn GREEN ARROW. Only one of the three indications shall be displayed at any given time. A signal instruction sign shall not be required with this set of signal indications. If used, it shall be a RIGHT ON GREEN ARROW ONLY (R10-5a) sign (see Figure 2B-27).
 2. Steady CIRCULAR RED, steady right-turn YELLOW ARROW, and right-turn GREEN ARROW. Only one of three indications shall be displayed at any given time. If the CIRCULAR RED signal indication is sometimes displayed when the signal faces for the adjacent through lane(s) are not displaying a CIRCULAR RED signal indication, a RIGHT TURN SIGNAL (R10-10R) sign (see Figure 2B-27) shall be used unless the CIRCULAR RED signal indication is shielded, hooded, louvered, positioned, or designed such that it is not readily visible to drivers in the through lane(s).
- B. During the protected right-turn movement, a right-turn GREEN ARROW signal indication shall be displayed.
- C. A steady right-turn YELLOW ARROW signal indication shall be displayed following the right-turn GREEN ARROW signal indication.
- D. When the separate signal face is providing a message to stop and remain stopped, a steady right-turn RED ARROW signal indication shall be displayed if it is intended that right turns on red not be permitted (except when a traffic control device is in place permitting a turn on a steady RED ARROW signal indication) or a steady CIRCULAR RED signal indication shall be displayed if it is intended that right turns on red be permitted.
- E. If the protected only mode is not the only right-turn mode used for the approach, the signal face shall be the same separate right-turn signal face that is used for the protected/permissive mode (see Section 4D.24 and Figure 4D-19) except that a flashing right-turn YELLOW ARROW or flashing right-turn RED ARROW signal indication shall not be displayed when operating in the protected only mode.

Section 4D.24 Signal Indications for Protected/Permissive Mode Right-Turn Movements

Option:

~~04—When an engineering study determines that each and every vehicle must successively come to a full stop before making a permissive right turn, a separate signal face that has a flashing right-turn RED ARROW signal indication during the permissive right-turn movement may be used.~~

Standard:

~~05—If a separate right-turn signal face is being operated in a protected/permissive right-turn mode and a flashing right-turn RED ARROW signal indication is provided, it shall meet the following requirements (see Figure 4D-15):~~

- ~~A. It shall be capable of displaying one of the following sets of signal indications:

 1. Steady or flashing right-turn RED ARROW, steady right-turn YELLOW ARROW, and right-turn GREEN ARROW. Only one of the three indications shall be displayed at any given time.
 2. Steady CIRCULAR RED on the left and steady or flashing right-turn RED ARROW on the right of the top position, steady right-turn YELLOW ARROW in the middle position, and right-turn GREEN ARROW in the bottom position. Only one of the four indications shall be displayed at any given time. If the CIRCULAR RED signal indication is sometimes displayed when the signal faces for the adjacent through lane(s) are not displaying a CIRCULAR RED signal indication, a RIGHT TURN SIGNAL (R10-10R) sign (see Figure 2B-27) shall be used unless the CIRCULAR RED signal indication in the separate right-turn signal face is shielded, hooded, louvered, positioned, or designed such that it is not readily visible to drivers in the through lane(s).~~
- ~~B. During the protected right-turn movement, a right-turn GREEN ARROW signal indication shall be displayed.~~
- ~~C. A steady right-turn YELLOW ARROW signal indication shall be displayed following the right-turn GREEN ARROW signal indication.~~
- ~~D. During the permissive right-turn movement, the separate right-turn signal face shall display a flashing right-turn RED ARROW signal indication.~~

- ~~E. A steady right-turn YELLOW ARROW signal indication shall be displayed following the flashing right-turn RED ARROW signal indication if the permissive right-turn movement is being terminated and the separate right-turn signal face will subsequently display a steady red indication.~~
- ~~F. When a permissive right-turn movement is changing to a protected right-turn movement, a right-turn GREEN ARROW signal indication shall be displayed immediately upon the termination of the flashing right-turn RED ARROW signal indication. A steady right-turn YELLOW ARROW signal indication shall not be displayed between the display of the flashing right-turn RED ARROW signal indication and the display of the steady right-turn GREEN ARROW signal indication.~~
- ~~G. When the separate right-turn signal face is providing a message to stop and remain stopped, a steady right-turn RED ARROW signal indication shall be displayed if it is intended that right turns on red not be permitted (except when a traffic control device is in place permitting a turn on a steady RED ARROW signal indication) or a steady CIRCULAR RED signal indication shall be displayed if it is intended that right turns on red be permitted.~~
- ~~H. It shall be permitted to display a flashing right-turn RED ARROW signal indication for a permissive right-turn movement while the signal faces for the adjacent through movement display steady CIRCULAR RED signal indications and the opposing left-turn signal faces display left-turn GREEN ARROW signal indications for a protected left-turn movement.~~
- ~~I. A supplementary sign shall not be required. If used, it shall be a RIGHT TURN YIELD ON FLASHING RED ARROW AFTER STOP (R10-27) sign (see Figure 2B-27).~~

Option:

- ~~⁰⁶ The requirements of Item A.1 in Paragraph 5 may be met by a vertically-arranged signal face with a horizontal cluster of two right-turn RED ARROW signal indications, the left-most of which displays a steady indication and the right-most of which displays a flashing indication (see Figure 4D-15).~~

Section 4D.25 Signal Indications for Approaches With Shared Left-Turn/Right-Turn Lanes and No Through Movement

Support:

- ~~⁰⁵ Figure 4D-20 4D-100 illustrates application of these Standards on approaches that have only a shared left-turn/right-turn lane, and on approaches that have one or more exclusive turn lanes in addition to the shared left-turn/right-turn lane.~~

CHAPTER 4E. PEDESTRIAN CONTROL FEATURES

Section 4E.02 Meaning of Pedestrian Signal Head Indications

Standard:

- ⁰¹ Pedestrian signal head indications shall have the following meanings:
- A. A steady WALKING PERSON (symbolizing WALK) signal indication means that a pedestrian facing the signal indication is permitted to start to cross the roadway in the direction of the signal indication, possibly in conflict with turning vehicles. The pedestrian shall yield the right-of-way to vehicles lawfully within the intersection at the time that the WALKING PERSON (symbolizing WALK) signal indication is first shown.
 - B. A flashing UPRAISED HAND (symbolizing DONT WALK) signal indication means that a pedestrian shall not start to cross the roadway in the direction of the signal indication, but that any pedestrian who has already started to cross on a steady WALKING PERSON (symbolizing WALK) signal indication shall proceed to the far side of the traveled way of the street or highway, unless otherwise directed by a traffic control device to proceed only to the median of a divided highway or only to some other island or pedestrian refuge area.
 - C. A steady UPRAISED HAND (symbolizing DONT WALK) signal indication means that a pedestrian shall not enter the roadway in the direction of the signal indication.
 - D. A flashing WALKING PERSON (symbolizing WALK) signal indication has no meaning and shall not be used.
- ^{01A} At all locations with a pedestrian signal indication, THE MEANING OF PEDESTRIAN SIGNALS (R10-101) sign or sticker shall be installed on each pole, between and immediately above the push buttons. These signs or stickers need not be reflectorized.

CHAPTER 4F. PEDESTRIAN HYBRID BEACONS

Section 4F.02 Design of Pedestrian Hybrid Beacons

Standard:

- 01 Except as otherwise provided in this Section, a pedestrian hybrid beacon shall meet the provisions of Chapters 4D and 4E.
- 02 A pedestrian hybrid beacon face shall consist of three signal sections, with a CIRCULAR YELLOW signal indication centered below two horizontally aligned CIRCULAR RED signal indications (see Figure 4F-3).
- 03 When an engineering study finds that installation of a pedestrian hybrid beacon is justified, then:
 - A. At least two pedestrian hybrid beacon faces shall be installed for each approach of the major street,
 - B. A stop line shall be installed for each approach to the crosswalk,
 - C. A pedestrian signal head conforming to the provisions set forth in Chapter 4E shall be installed at each end of the marked crosswalk, and
 - D. The pedestrian hybrid beacon shall be pedestrian actuated.
 - E. If a pedestrian hybrid beacon is installed at or immediately adjacent to an intersection with a side road or driveway, vehicular traffic on the side road or driveway shall be controlled by STOP signs.

Guidance:

- 04 When an engineering study finds that installation of a pedestrian hybrid beacon is justified, then:
 - A. ~~The pedestrian hybrid beacon should be installed at least 100 feet from side streets or driveways that are controlled by STOP or YIELD signs,~~
 - B. ~~Parking and other sight obstructions should be evaluated and prohibited for at least 100 feet in advance of and at least 20 feet beyond the marked crosswalk, or site accommodations should be made through curb extensions or other techniques to provide adequate sight distance if necessary,~~
 - C. The installation should include suitable standard signs and pavement markings, and
 - D. If installed within a signal system, the pedestrian hybrid beacon should be coordinated.

CHAPTER 4L. FLASHING BEACONS

Section 4L.01 General Design and Operation of Flashing Beacons

Standard:

- ⁰² Flashing Beacon units and their mountings shall comply with the provisions of Chapter 4D, except as otherwise provided in this Chapter.
- ⁰³ Beacons shall be flashed at a rate of not less than 50 or more than 60 times per minute. The illuminated period of each flash shall be a minimum of 1/2 and a maximum of 2/3 of the total cycle.
- ⁰⁴ A beacon shall not be included within the border of a sign ~~except for SCHOOL SPEED LIMIT sign-beacons~~ (see Sections 4L.04 and 7B.15).

Section 4L.02 Intersection Control Beacon

Standard:

- ⁰¹ An Intersection Control Beacon shall consist of one or more signal faces directed toward each approach to an intersection. Each signal face shall consist of one or more signal sections of a standard traffic signal face, with flashing CIRCULAR YELLOW or CIRCULAR RED signal indications in each signal face. They shall be installed and used only at an intersection to control two or more directions of travel.
- ⁰² Application of Intersection Control Beacon signal indications shall be limited to the following:
- A. Yellow on one route (normally the major street) and red for the remaining approaches, and
 - B. Red for all approaches (if the warrant described in Section 2B.07 for a multi-way stop is satisfied).
- ⁰³ Flashing yellow signal indications shall not face conflicting vehicular approaches.
- ⁰⁴ A STOP sign shall be used on approaches to which a flashing red signal indication is displayed on an Intersection Control Beacon (see Section 2B.04).
- ⁰⁵ If two horizontally aligned red signal indications are used on an approach for an Intersection Control Beacon, they shall be flashed simultaneously to avoid being confused with grade crossing flashing-light signals. If two vertically aligned red signal indications are used on an approach for an Intersection Control Beacon, they shall be flashed alternately.

Guidance:

- ⁰⁶ An Intersection Control Beacon should not be mounted on a pedestal in the roadway unless the pedestal is within the confines of a traffic or pedestrian island.

Option:

- ⁰⁷ Supplemental signal indications may be used on one or more approaches in order to provide adequate visibility to approaching road users.
- ⁰⁸ Intersection Control Beacons may be used at intersections where traffic or physical conditions do not justify conventional traffic control signals but crash rates indicate the possibility of a special need.
- ⁰⁹ An Intersection Control Beacon is generally located over the center of an intersection; however, it may be used at other suitable locations.

Support:

- ^{09A} Consider installing intersection control beacons when an intersection has experienced 4 or more angle crashes in a 12-consecutive month period or 6 or more in a 24-consecutive month period.

Section 4L.03 Warning Beacon

Standard:

- ⁰² A Warning Beacon shall consist of one or more signal sections of a standard traffic signal face with a flashing CIRCULAR YELLOW signal indication in each signal section.
- ⁰³ A Warning Beacon shall be used only to supplement an appropriate warning or regulatory sign or marker.
- ⁰⁴ Warning Beacons, if used at intersections, shall not face conflicting vehicular approaches.
- ⁰⁵ If a Warning Beacon is suspended over the roadway, the clearance above the pavement shall be a ~~minimum of 15 feet and a maximum of 19 feet~~ comply with the requirements of Section 4D.15.

CHAPTER 4Z. ACTIVE ADVANCE WARNING FLASHERS

[This is a new chapter. There is no corresponding chapter in the MUTCD.]

Section 4Z.01 Application of Active Advance Warning Flashers

Support:

01 Active Advance Warning Flashers (AAWFs) are a special type of highway traffic signal installed in advance of conventional traffic signals to provide advance notice of the onset of the yellow indication.

Option:

02 AAWFs may be installed only when the following conditions are met:

- A. Where sight distance to the conventional traffic signal indications meets or exceeds standards AND
- B. High-speed (55 mph or higher) approaches to an intersection spaced at least one mile from another signalized intersection OR
- C. At the first signalized intersection after 10 or more miles of uninterrupted highway

Support:

03 AAWFs impact traffic in two ways:

- A. They provide drivers advance notice of the onset of yellow
- B. They prevent traffic signal electronics from providing “Dilemma Zone Protection”, which attempts to hold the onset of yellow until there are no cars within the “Dilemma Zone” (the area where it is difficult to decide whether to stop or go).

04 When both factors apply, an engineering analysis could be used to consider the effects on signal operation, capacity, safety, and to evaluate specific mitigating strategies such as the addition or relocation of vehicle detectors. If only one approach meets the conditions of the Option statement, the engineering analysis could address the potential loss of dilemma zone protection and extended advance notice on the opposite approach and whether AAWFs on the opposite approach are desirable.

Section 4Z.02 Design of Active Advance Warning Flashers

Guidance:

01 *AAWFs should be installed approximately 500 feet in advance of the stop bar or as determined by an engineering analysis..*

02 *The AAWF sign and flashers should be designed to:*

- A. *Appear distinctively different than standard flashing signal ahead signs/beacons to alert drivers to its different meaning (impending yellow indication)*
- B. *Communicate at a glance that the warning refers to a signal, not construction activity, pedestrian crossing, etc.*
- C. *When the power goes out, it should not imply to drivers that they may proceed through the intersection, as a nonflashing “Prepare to Stop When Flashing” sign does.*
- D. *Be easily visible from all lanes on the approach*

03 *Figure 4Z-100 shows the recommended AAWF configuration*

Figure 4Z-100. Active Advance Warning Flasher

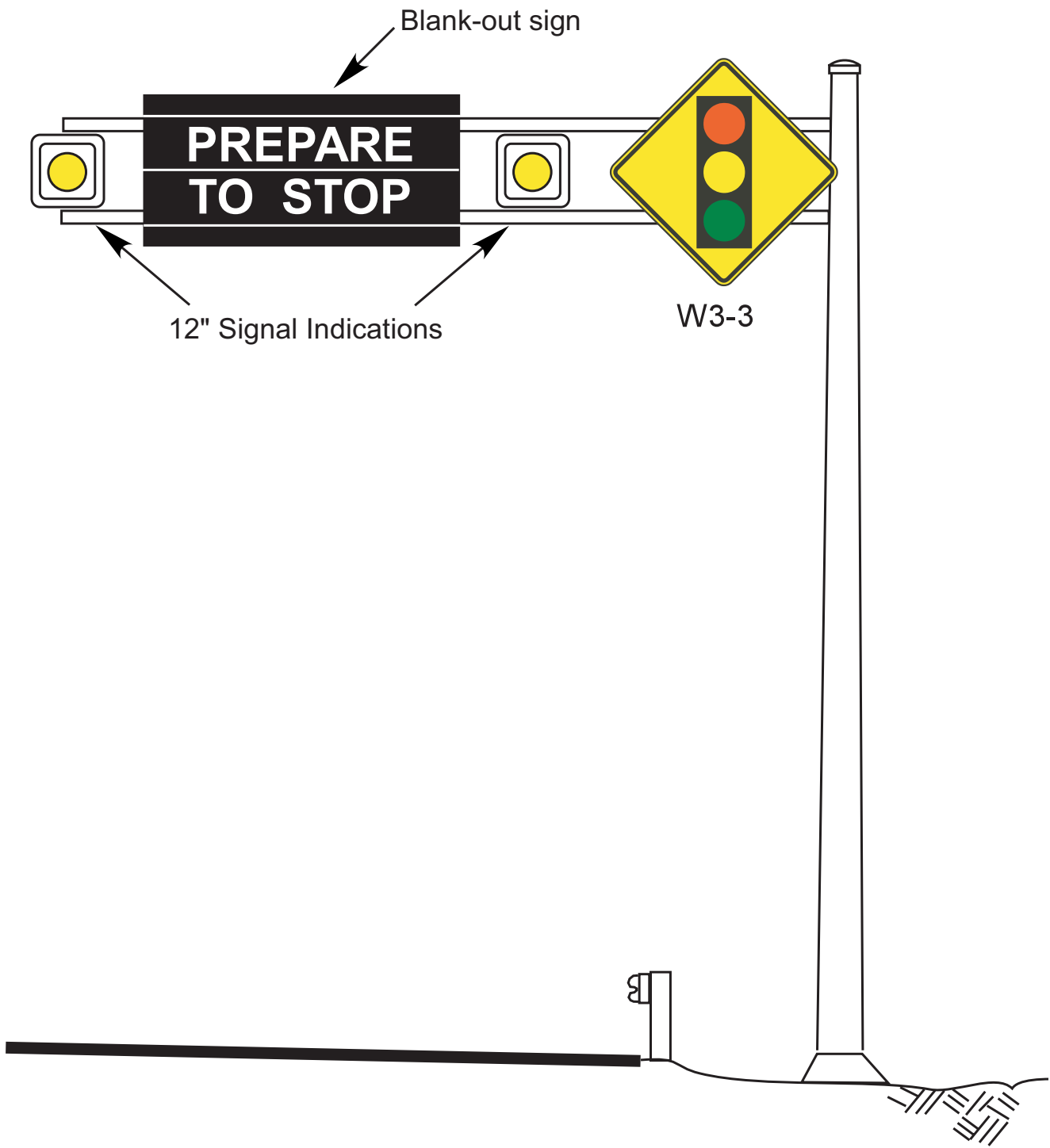

PART 5

TRAFFIC CONTROL DEVICES FOR LOW-VOLUME ROADS

CHAPTER 5A. GENERAL

Section 5A.04 Placement

Standard:

- ⁰¹ Except as provided in Paragraph 3, the traffic control devices used on low-volume roads shall be placed and positioned in accordance with the lateral, longitudinal, and vertical placement provisions contained in Part 2 and other applicable Sections of this Manual.

Guidance:

- ⁰² *The placement of warning signs should comply with the guidance contained in Section 2C.05 and other applicable Sections of this Manual.*

Option:

- ⁰³ A lateral offset of not less than 2 feet from the roadway edge to the roadside edge of a sign may be used where roadside features such as terrain, shrubbery, and/or trees prevent lateral placement in accordance with Section 2A.19.

Support:

- ^{03A} Investigate clearing the vegetation before locating signs as close to the edge of the road as 2 feet.

CHAPTER 5C. WARNING SIGNS

[Delete the asterisk note in Figure 5C-2 of the 2009 MUTCD and all associated asterisks in the figure.]

Section 5C.10 Advisory Speed Plaque (W13-1P)

Option:

01 An Advisory Speed (W13-1P) plaque (see Figure 5C-1) may be mounted below a warning sign when the condition requires a reduced speed.

01A See Section 2C.08 of the 2009 MUTCD for additional information on the use of these signs.

Section 5C.12 NO TRAFFIC SIGNS Sign (W18-1)

Option:

~~01 A W18-1 warning sign (see Figure 5C-2) with the legend NO TRAFFIC SIGNS may be used only on unpaved, low-volume roads to advise users that no signs are installed along the distance of the road. If used, the sign may be installed at the point where road users would enter the low-volume road or where, based on engineering judgment, the road user might need this information.~~

~~02 A W7-3aP, W16-2P, or W16-9P supplemental plaque (see Figure 5C-2) with the legend NEXT XX MILES, XX FEET, or AHEAD may be installed below the W18-1 sign when appropriate.~~

Support:

02A See Subsection 5C.100.

[Delete the NO TRAFFIC SIGNS (W18-1) sign from Figure 5C-2 of the 2009 MUTCD.]

Section 5C.100 PRIMITIVE ROAD NO WARNING SIGNS Sign (W16-113)

Option:

01 The PRIMITIVE ROAD NO WARNING SIGNS sign (W16-113) may be used on low-volume roads with the following characteristics:

- A. AADT of less than 25, and
- B. Soil or gravel surface

02 In addition to installing this sign at the beginning of the no-warning sign area, additional signs may be installed at intermediate points within the area.

Standard:

03 The Advisory Distance Plaque (W7-3aP) shall be installed below the W16-113 sign.

CHAPTER 5E. MARKINGS

Section 5E.03 Edge Line Markings

Support:

01 The purpose of edge line markings is to delineate the left-hand or right-hand edge of the roadway.

Guidance:

02 *Edge line markings should be considered for use on paved low-volume roads based on engineering judgment or an engineering study.*

Option:

03 Edge line markings may be placed on highways with or without center line markings.

04 Edge line markings may be placed on paved low-volume roads for roadway features such as horizontal curves, narrow bridges, pavement width transitions, curvilinear alignment, and at other locations based on engineering judgment or an engineering study.

04A If edge line markings are placed without centerline markings, the Two-Way (W6-3) sign may be used where road users could perceive that they are on a one-way roadway when, in fact, they are on a two lane, two-way highway.

CHAPTER 5F. TRAFFIC CONTROL FOR HIGHWAY-RAIL GRADE CROSSINGS

Section 5F.02 Grade Crossing (Crossbuck) Sign and Number of Tracks Plaque (R15-1, R15-2P)

Standard:

- 02 The Crossbuck (R15-1) sign shall be used at all highway-rail grade crossings, except as otherwise provided in Section 8B.03. For all low-volume roads, Crossbuck signs shall be used on the right-hand side of each approach. If there are two or more tracks, the supplemental Number of Tracks (R15-2P) plaque (see Figure 5F-1) shall display the number of tracks and shall be installed below the Crossbuck sign.
- 03 A strip of high-intensity or brighter retroreflective white material not less than 26 inches in width shall be ~~used~~ mounted on the back of each blade of each Crossbuck sign for the length of each blade, at all highway-rail grade crossings, except those where Crossbuck signs have been installed back-to-back.
- 04 A vertical strip of high-intensity or brighter retroreflective white material, not less than 2 inches in width, shall be ~~used~~ mounted on each support at passive highway-rail grade crossings for the full length of the front and back of the support from the Crossbuck sign or Number of Tracks plaque to within 2 feet above the ground, except on the side of those supports where a STOP (R1-1) or YIELD (R1-2) sign or flashing lights have been installed or on the back side of supports for Crossbuck signs installed on one-way streets.

PART 6

TEMPORARY TRAFFIC CONTROL

CHAPTER 6A. GENERAL

Section 6A.01 General

Standard:

- 10 TTC plans and devices shall be the responsibility of the authority of a public body or official having jurisdiction for guiding road users. There shall be adequate statutory authority for the implementation and enforcement of needed road user regulations, parking controls, speed zoning, and the management of traffic incidents. Such statutes shall provide sufficient flexibility in the application of TTC to meet the needs of changing conditions in the TTC zone.**
- 10A DOT&PF Policy and Procedure 05.05.020, Establishment of Speed Limits and Zones, shall be followed when establishing speed limits for DOT&PF construction zones.**
- 10B DOT&PF Policy and Procedure 05.05.015, Highway Work Zone Safety and Mobility, shall be followed to determine whether all elements of a Transportation Management Plan are required and for establishing pay items related to traffic control activities and materials.**

CHAPTER 6B. FUNDAMENTAL PRINCIPLES

Section 6B.01 Fundamental Principles of Temporary Traffic Control

[Insert the following at the end of Section 6B.01:]

Guidance:

^{09A} *Generally, signs should not be posted on construction projects directing motorists to businesses. However, it may be necessary when one of the following conditions exists:*

A. A. When a business that was previously easily visible from the road is completely obscured by road construction activity.

B. B. When the route to a business that was previously readily evident from the road is obscured by road construction activity.

^{09B} *Temporary business-identifying signs should be removed immediately when conditions A. and B. cease to exist.*

^{09C} *Temporary business-identifying signs should be designed so they will not be confused with official construction, warning, directional, or regulatory signs.*

^{09D} *Temporary business-identifying signs should not be installed for the purposes of advertising. They are only acceptable as mitigation for construction activities that obscure the business or the route to it.*

Standard

^{09E} **Temporary business-identifying signs shall have black legends and borders on orange retroreflective backgrounds.**

CHAPTER 6C. TEMPORARY TRAFFIC CONTROL ELEMENTS

Section 6C.01 Temporary Traffic Control Plans

Guidance:

- 09 *This alternate or modified plan should have the approval of the responsible highway agency prior to implementation.*
- 10 *Provisions for effective continuity of transit service should be incorporated into the TTC planning process because often public transit buses cannot efficiently be detoured in the same manner as other vehicles (particularly for short-term maintenance projects). Where applicable, the TTC plan should provide for features such as accessible temporary bus stops, pull-outs, and satisfactory waiting areas for transit patrons, including persons with disabilities, if applicable (see Section 8A.08 for additional light rail transit issues to consider for TTC).*
- 11 *Provisions for effective continuity of railroad service and acceptable access to abutting property owners and businesses should also be incorporated into the TTC planning process.*
- 12 *Reduced speed limits should be used only in the specific portion of the TTC zone where conditions or restrictive features are present. However, frequent changes in the speed limit should be avoided. A TTC plan should be designed so that vehicles can travel through the TTC zone with a speed limit reduction of no more than 10 mph.*
- 13 *A reduction of more than 10 mph in the speed limit should be used only when required by restrictive features in the TTC zone. Where restrictive features justify a speed reduction of more than 10 mph, additional driver notification should be provided. The speed limit should be stepped down in advance of the location requiring the lowest speed, and additional TTC warning devices should be used.*
- 14 *Reduced speed zoning (lowering the regulatory speed limit) should be avoided as much as practical because drivers will reduce their speeds only if they clearly perceive a need to do so.*

Standard:

- 14A **If used, reduced speed zoning shall be conducted in accordance with DOT&PF Policy and Procedure 05.05.020, Establishment of Speed Limits and Zones.**

Support:

- 15 Research has demonstrated that large reductions in the speed limit, such as a 30 mph reduction, increase speed variance and the potential for crashes. Smaller reductions in the speed limit of up to 10 mph cause smaller changes in speed variance and lessen the potential for increased crashes. A reduction in the regulatory speed limit of only up to 10 mph from the normal speed limit has been shown to be more effective.

[Revise Table 6C-1 of the 2009 MUTCD as shown in this ATMS.]

Table 6C-1. Recommended Advance Warning Sign Minimum Spacing

Road Type	Distance Between Signs**		
	A	B	C
Urban (low speed)*	100 feet	100 feet	100 feet
Urban (high speed)*	350 feet	350 feet	350 feet
Rural	500 feet	500 feet	500 feet
Expressway / Freeway***	1,000 feet	1,500 feet	2,640 feet

* ~~Speed category to be determined by the highway agency.~~ In this table, low speed is defined as a posted speed of 40 mph or less, and high speed is defined as a posted speed of 45 mph or greater.

** The column headings A, B, and C are the dimensions shown in Figures 6H-1 through 6H-46. The A dimension is the distance from the transition or point of restriction to the first sign. The B dimension is the distance between the first and second signs. The C dimension is the distance between the second and third signs. (The “first sign” is the sign in a three-sign series that is closest to the TTC zone. The “third sign” is the sign that is furthest upstream from the TTC zone.)

*** For facilities classified as expressways in urban areas, apply the Urban – High Speed spacing criteria.

CHAPTER 6E. FLAGGER CONTROL

Section 6E.03 Hand-Signaling Devices

Standard:

- ⁰² The STOP/SLOW paddle shall have an octagonal shape on a rigid handle. ~~STOP/SLOW paddles shall be at least 18 inches wide with letters at least 6 inches high.~~ STOP/SLOW paddles (W23-100) shall be at least 18 inches wide with letters 6 inches high for local roads with speed limits less than or equal to 25 mph and shall be 24 inches wide with letters 8 inch high for all other roads. The STOP (R1-1) face shall have white letters and a white border on a red background. The SLOW (W20-8) face shall have black letters and a black border on an orange background. When used at night, the STOP/SLOW paddle shall be retroreflectorized.
- ⁰³ The STOP/SLOW paddle shall be fabricated from light semi-rigid material.

Guidance:

- ~~⁰⁴ The STOP/SLOW paddle should be fabricated from light semi-rigid material.~~

CHAPTER 6F. TEMPORARY TRAFFIC CONTROL ZONE DEVICES

[Revise Table 6F-1 of the 2009 MUTCD as shown in this ATMS. The remainder of Table 6F-1 remains as shown in the 2009 MUTCD.]

Table 6F-1. Temporary Traffic Control Zone Sign and Plaque Sizes (Sheet 1 of 3)

Sign or Plaque	Sign Designation	Section	Conventional Road	Freeway or Expressway	Minimum
...					
Stop (on Stop/Slow Paddle)	R1-1	6E.03	48x48 24x24	—	18x18
...					
Slow (on Stop/Slow Paddle)	W20-8	6E.03	48x48 24x24	—	18x18

Section 6F.03 Sign Placement

Standard:

- ~~04 The minimum height, measured vertically from the bottom of the sign to the elevation of the near edge of the pavement, of signs installed at the side of the road in rural areas shall be 5 feet (see Figure 6F-1).~~
- 04A Post-mounted signs installed at the side of the road in rural areas shall be mounted at a height of at least 7 feet, measured from the bottom of the sign to the near edge of the pavement (see revised Figure 6F-1).
- 05 The minimum height, measured vertically from the bottom of the sign to the top of the curb, or in the absence of curb, measured vertically from the bottom of the sign to the elevation of the near edge of the traveled way, of signs installed at the side of the road in business, commercial, or residential areas where parking or pedestrian movements are likely to occur, or where the view of the sign might be obstructed, shall be 7 feet (see Figure 6F-1).
- 06 The minimum height, measured vertically from the bottom of the sign to the sidewalk, of signs installed above sidewalks shall be 7 feet.

Figure 6F-1. Height and Lateral Location of Signs—Typical Installations

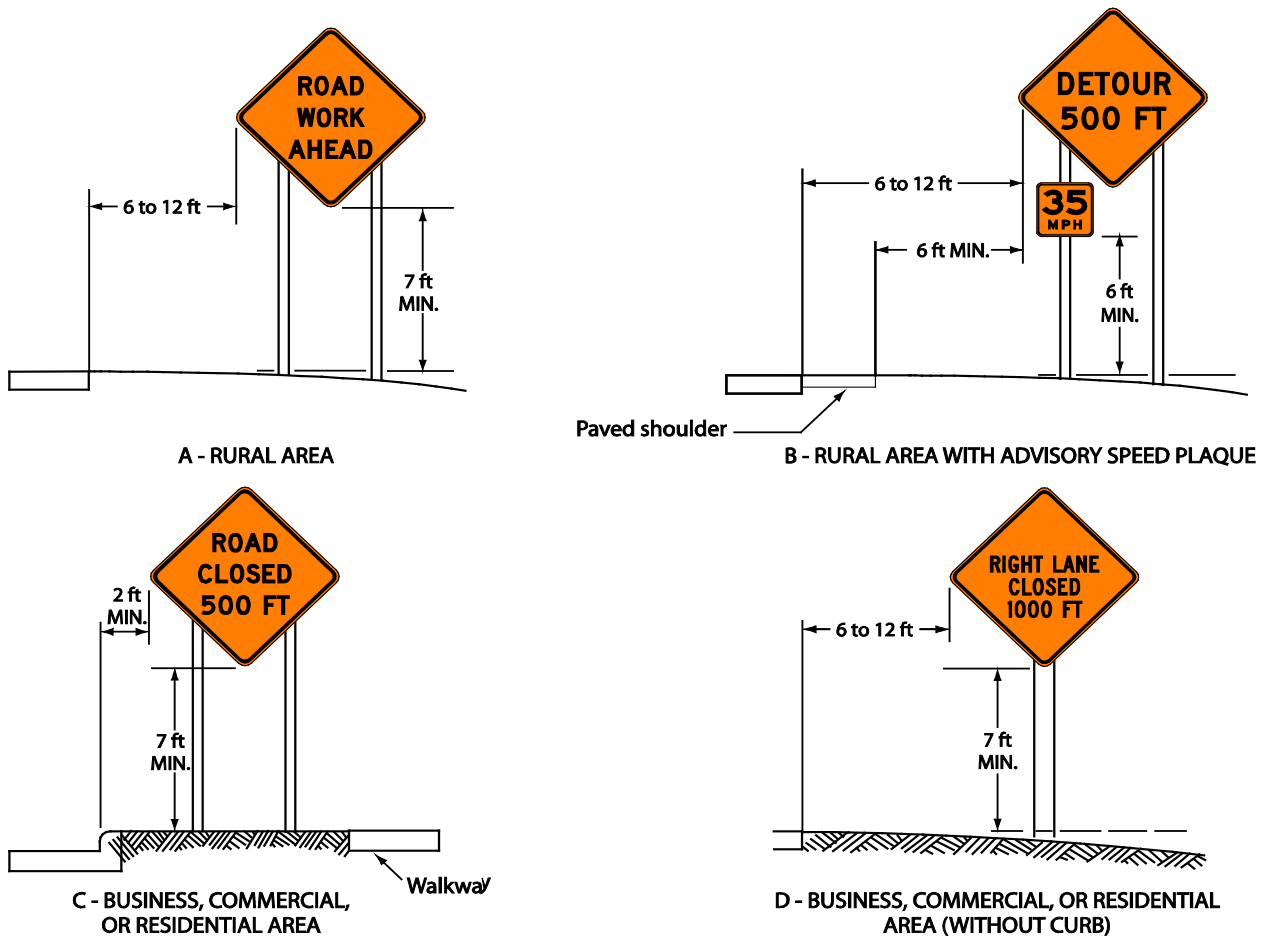

Section 6F.12 Work Zone and Higher Fines Signs and Plaques

Option:

01—A WORK ZONE (G20-5aP) plaque (see Figure 6F-3) may be mounted above a Speed Limit sign to emphasize that a reduced speed limit is in effect within a TTC zone. An END WORK ZONE SPEED LIMIT (R2-12) sign (see Figure 6F-3) may be installed at the downstream end of the reduced speed limit zone.

Guidance:

02—A BEGIN HIGHER FINES ZONE (R2-10) sign (see Figure 6F-3) should be installed at the upstream end of a work zone where increased fines are imposed for traffic violations, and an END HIGHER FINES ZONE (R2-11) sign (see Figure 6F-3) should be installed at the downstream end of the work zone.

Option:

03—Alternate legends such as BEGIN (or END) DOUBLE FINES ZONE may also be used for the R2-10 and R2-11 signs.

04—A FINES HIGHER, FINES DOUBLE, or \$XX FINE plaque (see Section 2B.17 and Figure 6F-3) may be mounted below the Speed Limit sign if increased fines are imposed for traffic violations within the TTC zone.

05—Individual signs and plaques for work zone speed limits and higher fines may be combined into a single sign or may be displayed as an assembly of signs and plaques.

Section 6F.12 Double Fine in Work Zone Signs (R16-100, R16-101, R16-102, R2-100, W20-102)

Support:

01A The WORK ZONE, BEGIN DOUBLE TRAFFIC FINES (R16-100) and END DOUBLE TRAFFIC FINES (R16-101) signs legally establish the beginning and end of double fine zones. See 13 AAC 40.010 and 17 AAC 99.010. See Section 2B.17.

Standard:

02A **On DOT&PF construction projects, the DOT&PF regional traffic and safety engineer or the traffic control coordinator shall identify projects to receive double fine signs. On DOT&PF maintenance projects, the regional maintenance and operations chief shall make that decision. All decisions shall be made in accordance with the information given in this section.**

Guidance:

03A *Double fine signs should be posted in designated double fine zones in all road construction, repair, maintenance, or utility work areas except for the following:*

- A. *Mobile operations, such as striping, grading, brush cutting, etc.*
- B. *Work on low-volume, low-speed roads*
- C. *Pilot car operations that extend the entire length of a project*
- D. *Work that will last less than 48 hours*

Option:

04A Double fine signs may be omitted when work zones are shorter than one mile.

Standard:

05A **Within the previously-described road work areas, roadway segments where one or more of the following conditions exist are designated double fine zones:**

- A. **Active work areas: Areas where road workers and/or machinery are presently working on or adjacent to a road.**
- B. **Detours on new temporary roads built for that purpose; this does not include detours on existing streets.**
- C. **Sections of paved roads where pavement has been removed.**
- D. **Roads where unmatched asphalt lifts result in a vertical lip between lanes.**

06A **Double fine signs shall be used only in designated double fine zones. They shall be removed or covered when work ceases for more than two days and conditions B through D of this Standard subsection do not exist.**

07A **Double fine signs shall be confined to areas where the above conditions exist, with the following exceptions:**

Option:

- 08A A. If the project is 2 miles or shorter in length, the entire project may be posted for double fines when the above conditions exist on any part of the project.
- B. When the above conditions exist at multiple locations separated by less than 2 miles, the locations and intervening segments may be posted as a single double fine zone.

Support:

09A “Work Zone Speed Limit Signs,” as used here, refer either to WORK ZONE SPEED LIMIT XX DOUBLE FINES (R2-100) signs or standard SPEED LIMIT (R2-1) signs with DOUBLE FINES (W20102) plaques mounted below them.

Standard:

10A **The speed limit shown on Work Zone Speed Limit signs may be either the existing limit before work began or, if a work zone speed order has been approved in accordance with DOT&PF Procedure 05.05.020, a reduced limit.**

11A **Work Zone Speed Limit signs shall be posted at the beginning of every double fine zone, regardless of whether the speed limit has been reduced from the preconstruction limit.**

12A **The END DOUBLE FINES (R16-101) sign shall be posted at the end of every double fine zone.**

13A **The speed limit for the road beyond the construction zone shall be posted at the end of every double fine zone.**

- 14A **All existing regulatory speed limit signs within the double fines zone shall either be replaced with Work Zone Speed Limit (R2-100) signs or supplemented with W20-102 plaques.**
- 15A **When a double fine zone is longer than 2 miles, Work Zone Speed Limit signs shall be posted at spacings not greater than 2 miles within the double fines zone.**
- 16A **Signs shall be installed at major intersections within the double fine zones, using one of the following methods to warn entering drivers of double fines:**
- A. **Install work zone speed limit signs on the main street on either side of the intersection.**
 - B. **Install Work Zone Begin Double Traffic Fines (R16-100) signs with W1-7 Arrow Panels mounted below them on the side street(s). The use of this signing eliminates the need for Road Work Ahead (W20-100) signs.**

Option:

- 17A **DOUBLE FINES WHERE POSTED (R16-102) signs may be posted at Alaska border entry points or at other locations where it is important to notify drivers of Alaska's double fines law.**

Support:

- 18A **The use of the double fines zone signs is not intended to be a reason for diminishing the number of warning signs that would normally be required in the work zone.**
- 19A **Overuse of the double fine signs will diminish respect for, and effectiveness of, the signs. It will also result in needlessly increased fines for traffic citations.**

Section 6F.16 Warning Sign Function, Design, and Application

Support:

- 01 **TTC zone warning signs (see Figure 6F-4) notify road users of specific situations or conditions on or adjacent to a roadway that might not otherwise be apparent.**

Standard:

- 02 **TTC warning signs shall comply with the Standards for warning signs presented in Part 2 and in FHWA's "Standard Highway Signs and Markings" book (see Section 1A.11). Except as provided in Paragraph 3, TTC warning signs shall be diamond-shaped with a black legend and border on an orange background, except for the W10-1 sign which shall have a black legend and border on a yellow background, and except for signs that are required or recommended in Parts 2 or 7 to have fluorescent yellow-green backgrounds.**

Option:

- 03 **Warning signs used for TTC incident management situations may have a black legend and border on a fluorescent pink background.**
- 04 **Mounting or space considerations may justify a change from the standard diamond shape.**
- 05 **In emergencies, available warning signs having yellow backgrounds may be used in TTC construction-related situations if signs with orange or fluorescent pink backgrounds are not at hand.**
- 05A **All warning signs may be used in construction and maintenance operations if the background color is orange, in accordance with Section 6F.02.**

Guidance:

- 06 *Where roadway or road user conditions require greater emphasis, larger than standard size warning signs should be used, with the symbol or legend enlarged approximately in proportion to the outside dimensions.*
- 07 *Where any part of the roadway is obstructed or closed by work activities or incidents, advance warning signs should be installed to alert road users well in advance of these obstructions or restrictions.*
- 08 *Where road users include pedestrians, the provision of supplemental audible information or detectable barriers or barricades should be considered for people with visual disabilities.*
- 08A *Unless otherwise noted, TTC signs should be located in advance of the condition of concern by the distance given in Section 2C.05, Table 2C-4 of the MUTCD.*

Support:

- 09 **Detectable barriers or barricades communicate very clearly to pedestrians who have visual disabilities that they can no longer proceed in the direction that they are traveling.**

Option:

¹⁰ Advance warning signs may be used singly or in combination.

¹¹ Where distances are not displayed on warning signs as part of the message, a supplemental plaque with the distance legend may be mounted immediately below the sign on the same support.

Section 6F.30 NEW TRAFFIC PATTERN AHEAD Sign (W23-2)

Option:

~~⁰¹ A NEW TRAFFIC PATTERN AHEAD (W23-2) sign (see Figure 6F-4) may be used on the approach to an intersection or along a section of roadway to provide advance warning of a change in traffic patterns, such as revised lane usage, roadway geometry, or signal phasing.~~

~~Guidance:~~

~~⁰² To retain its effectiveness, the W23-2 sign should be displayed for up to 2 weeks, and then it should be covered or removed until it is needed again.~~

Section 6F.30 NEW TRAFFIC PATTERN (W3-100)

Guidance:

^{01A} The NEW TRAFFIC PATTERN (W3-100) sign should be used to notify motorists of signal phasing modifications, traffic re-routing, etc.

Section 6F.31 Flagger Signs (W20-7, W20-7a)

Guidance:

⁰¹ The Flagger (W20-7) symbol sign (see Figure 6F-4) should be used in advance of any point where a flagger is stationed to control road users.

Option:

⁰² A distance legend may be displayed on a supplemental plaque below the Flagger sign. The sign may be used with appropriate legends or in conjunction with other warning signs, such as the BE PREPARED TO STOP (W3-4) sign (see Figure 6F-4).

⁰³ The FLAGGER (W20-7a) word message sign with distance legends may be substituted for the Flagger (W20-7) symbol sign.

Standard:

^{03A} **The Flagger sign shall be removed, covered, or turned away from road users when the flagging operations are not occurring.**

Section 6F.45 UNEVEN LANES Sign (W8-11)

Guidance:

⁰¹ The UNEVEN LANES (W8-11) sign (see Figure 6F-4) should be used during operations that create a greater than 1 inch difference in elevation on a vertical or near-vertical edge between adjacent lanes that are open to travel.

Section 6F.52 Advisory Speed Plaque (W13-1P)

Standard:

⁰² **The Advisory Speed plaque shall not be used in conjunction with any sign other than a warning sign, nor shall it be used alone. When used with orange TTC zone signs, this plaque shall have a black legend and border on an orange background. The sign shall be at least 24 x 24 inches in size when used with a sign that is 36 x 36 inches or larger. Except in emergencies, an Advisory Speed plaque shall not be mounted until the recommended speed is determined by the highway agency.**

^{02A} **Advisory speeds shall be determined using Section 2C.08.**

Section 6F.56 ROAD WORK NEXT XX MILES Sign (G20-1)

Guidance:

- 01 The ROAD WORK NEXT XX MILES (G20-1) sign (see Figure 6F-4) should be installed in advance of TTC zones that are more than 2 miles in length.*
- 01A The total length of the work zone should be based on a single, continuous work zone and should not consist of a sequence of discontinuous shorter work zones.*

(This page left intentionally blank.)

PART 7

TRAFFIC CONTROL FOR SCHOOL AREAS

CHAPTER 7A. GENERAL

Section 7A.02 School Routes and Established School Crossings

Support:

- 01A Planning of student transportation to and from school is primarily a responsibility of the local school district.
- 01 To establish a safer route to and from school for schoolchildren, the application of planning criterion for school walk routes might make it necessary for children to walk an indirect route to an established school crossing located where there is existing traffic control and to avoid the use of a direct crossing where there is no existing traffic control.

Guidance:

- 02 *School walk routes should be planned to take advantage of existing traffic controls.*
- 03 *The following factors should be considered when determining the feasibility of requiring children to walk a longer distance to a crossing with existing traffic control:*
- A. *The availability of adequate sidewalks or other pedestrian walkways to and from the location with existing control,*
 - B. *The number of students using the crossing,*
 - C. *The age levels of the students using the crossing, and*
 - D. *The total extra walking distance.*
- 03A *Before designated school zones are established, a team consisting of representatives of the local school district, local government, law enforcement agency and the highway authority should convene to discuss student transportation issues, walking routes, reduced school speed limits, and designated road crossings for students. When a school route plan has been approved by the local school district and accepted by the highway authority, the regional traffic and safety engineer or city traffic engineer should select the appropriate traffic control devices in accordance with Sections 7A.100 and 7A.101.*

Section 7A.04 Scope

Standard:

- 01 **Part 7 sets forth basic principles and prescribes standards that shall be followed in the design, application, installation, and maintenance of all traffic control devices (including signs, signals, and markings) and other controls (including adult crossing guards) required for the special pedestrian conditions in school areas.**

Support:

- 02 Sections 1A.01 and 1A.08 contain information regarding unauthorized devices and messages. Sections 1A.02 and 1A.07 contain information regarding the application of standards. Section 1A.05 contains information regarding the maintenance of traffic control devices. Section 1A.08 contains information regarding placement authority for traffic control devices. Section 1A.09 contains information regarding engineering studies and the assistance that is available to jurisdictions that do not have engineers on their staffs who are trained and/or experienced in traffic control devices.
- 03 Provisions contained in Chapter 2A and Section 2B.06 are applicable in school areas.
- 04 Part 3 contains provisions regarding pavement markings that are applicable in school areas.
- 05 Part 4 contains provisions regarding highway traffic signals that are applicable in school areas. The School Crossing signal warrant is described in Section 4C.06.
- 05A The urban and rural traffic control matrices presented in Table 7A-100 and Table 7A-101 apply only to roads abutting school property and nonabutting roads at designated school crossings.

Section 7A.100 Rural School Area Traffic Control Summary

[This is a new section. There is no corresponding section in the MUTCD.]

Guidance:

- 01 *Traffic control treatment of rural school areas should conform to Table 7A-100.*
- 02 *School districts should consider providing crossing guards where students in grades K-8 (K-4 in particular) are required to cross major streets.*
- 03 *On state roads, any significant deviation from the traffic control treatments shown in Table 7A-100 should be supported by written justification in accordance with procedures for Design Criteria Waiver, as outlined in Chapter 11 of the Alaska Highway Preconstruction Manual.*

Support:

- 04 For this application, “rural” is defined as a sparsely populated area where the majority of land is not subdivided.
- 05 Rural schools have different traffic control than urban schools because there are generally fewer students that must walk to school. Students are usually bused or driven because these areas are more sparsely settled and homes are farther away. Placing 20 mph zones on rural high speed roads where few student pedestrians are seen by drivers would generate disrespect for school speed zones in general, thereby making all school zones less safe.

Section 7A.101 Urban School Area Traffic Control Summary

[This is a new section. There is no corresponding section in the MUTCD.]

Guidance:

- 01 *Traffic control treatment of urban school areas should conform to Table 7A-101.*
- 02 *On state roads, any significant deviation from the traffic control treatments shown in Table 7A-101 should be supported by written justification in accordance with procedures for Design Criteria Waiver, as outlined in Chapter 11 of the Alaska Highway Preconstruction Manual.*

Table 7A-100. Rural School Area Traffic Control

Road Adjacent to School Grounds		Road Not Adjacent to School Grounds
Speed Limit <35 mph	Speed Limit >40 mph	School Area traffic control devices should not be placed on roads that do not abut school grounds unless a crossing guard is present at the site. Any exceptions to this rule shall be based on a site-specific engineering study.
School Area Signs (S1-1)	School Area Signs (S1-1) with a pedestrian-actuated beacon	

Table 7A-101. Urban School Area Traffic Control (Sheet 1 of 2)

Urban School Area Traffic Control Guidelines (Applies Only to Roads Abutting School Property and Non-Abutting Roads at Designated School Crossings)												
Grade Level (Lowest Grade Taught at School)	Students Required to Cross Road at Grade										Students Not Required to Cross Road at Grade (Could be grade-separated or just no crossing)	
	Traffic Signal At Crossing		No Traffic Signal at Crossing									
			STOP Controlled Crossing	Crossing Not STOP-Controlled				Insufficient Gaps (2) Address by re-routing students, busing students, or one of the following:				Completely Fenced? (1)
	Sufficient Gaps (2)			Crossing Guard (5) (6)		Grade Separation	Ped Signal or Ped Hybrid Beacon (if warranted) (3)	Mid-Street Refuge Island (7)				
	Existing Speed Limit <=20	Existing Speed Limit >20		Ex. Spd Limit <=20	Ex. Spd Limit >20				Yes	No		
9-12	C <input type="checkbox"/>	C	C (major streets only) <input type="checkbox"/>	C	C	N/A	N/A	See Students Not Required to Cross Road At-Grade	See Students Required to Cross Road At-Grade/Traffic Signal at Crossing	If refuge provides sufficient gaps, See Cross At-Grade/No Signal/No STOP/Sufficient Gaps. If not, choose another solution	<input type="checkbox"/>	
5-8	C	CG?	C (major streets only) G? <input type="checkbox"/>	C	CG?	CG	CG				<input type="checkbox"/>	
K-4	CG?	CG?	C (major streets only) G? <input type="checkbox"/>	CG?	CG?	CG	CG				<input type="checkbox"/>	

LEGEND	
n/a	Does not apply - Crossing Guards should not be used for high school students.
<input type="checkbox"/>	No School Signs
	School Area Sign (S1-1 and W16-9p) only
	School Advance Crossing (S1-1 and W16-9p) and School Crossing (S1-1 and W16-9p). Overhead S1-1 sign optional. (4)
	School Advance Crossing and School Crossing Signs +20 MPH When Flashing (S5-1) with flasher, or 20 MPH School Speed Limit Assemblies (with S4-1P, S4-2P, S4-4P, or S4-6P plates). Overhead S1-1 sign optional. (4)
C	Marked Crosswalk - install at nearest intersection, if within 400 ft. If there is already a crosswalk within 400 feet, use it as a school crosswalk. Use school crosswalk signs at mid-block locations if within a school zone.
G	Crossing Guard
G?	School districts should consider crossing guards at major street crossings.

See next page for notes.

Table 7A-101. Urban School Area Traffic Control (Sheet 2 of 2)

- (1) "Completely fenced" means fencing that restricts all access from the street side of the school to the street.
- (2) See Section 7A.03 of the MUTCD for gap sufficiency determination: When gaps are insufficient for crossing, student re-routing, busing, or mid-street pedestrian refuge islands should be the first options considered. Guards or pedestrian signals should be viewed as last resorts.
- (3) Traffic signals may be installed (but are not mandated) for pedestrians when the Minimum Pedestrian Volume or School Crossing warrants defined in Sections 4C.05 and 4C.06 of the MUTCD are met. Although these signals may be installed mid-block, every effort should be made to install them at intersections and run them as conventional signals. Where the warrants for installing a pedestrian traffic signal are not met, pedestrian hybrid beacons should be considered according to the guidelines defined in Section 4F.01 of the MUTCD.
- (4) The "Overhead S1-1 sign" referenced in the legend is a S1-1 school crossing sign hung over the road at or near the crosswalk. Sign illumination (see Section 2A.07) or flashing beacons (see Chapter 4L) associated with the overhead sign should be considered to enhance driver awareness of the crossing. If the site has advance school flashers, the overhead flashers should flash when the advance school flashers flash.
- (5) Crossing guards are only a solution on streets with inadequate gaps when policy allows guards to create, rather than just extend, gaps in traffic.
- (6) Crossing guards should not be used when streets have more than three lanes.
- (7) Mid-street pedestrian refuges increase the number of gaps of sufficient duration for crossing by splitting the crossing into two parts, which:
 - (a) Reduces gap duration necessary for crossing by reducing crossing distance, and
 - (b) Increases gap frequency by reducing the conflicting traffic volume.Pedestrian refuges should be at least 6 feet wide.

CHAPTER 7B. SIGNS

Section 7B.08 School Sign (S1-1) and Plaques

Support:

- ⁰¹ Many state and local jurisdictions find it beneficial to advise road users that they are approaching a school that is adjacent to a highway, where additional care is needed, even though no school crossing is involved and the speed limit remains unchanged. Additionally, some jurisdictions designate school zones that have a unique legal standing in that fines for speeding or other traffic violations within designated school zones are increased or special enforcement techniques such as photo radar systems are used. It is important and sometimes legally necessary to mark the beginning and end points of these designated school zones so that the road user is given proper notice.
- ⁰² The School (S1-1) sign (see Figure 7B-1) has the following four applications:
- A. School Area – the S1-1 sign can be used to warn road users that they are approaching a school area that might include school buildings or grounds, a school crossing, or school related activity adjacent to the highway.
 - B. School Zone – the S1-1 sign can be used to identify the location of the beginning of a designated school zone (see Section 7B.09).
 - C. School Advance Crossing – if combined with an AHEAD (W16-9P) plaque or an XX FEET (W16-2P or W16-2aP) plaque to comprise the School Advance Crossing assembly, the S1-1 sign can be used to warn road users that they are approaching a crossing where schoolchildren cross the roadway (see Section 7B.11).
 - D. School Crossing – if combined with a diagonal downward pointing arrow (W16-7P) plaque to comprise the School Crossing assembly, the S1-1 sign can be used to warn approaching road users of the location of a crossing where schoolchildren cross the roadway (see Section 7B.12).
- ^{02A} Figure 7B-100 contains information regarding the application and placement of the School Sign (S1-1).

Section 7B.09 School Zone Sign (S1-1) and Plaques (S4-3P, S4-7P) and END SCHOOL ZONE Sign (S5-2)

Standard:

- ⁰¹ ~~If a school zone has been designated under State or local statute as described in Section 7A.02, a School (S1-1) sign (see Figure 7B-1) shall be installed to identify the beginning point(s) of the designated school zone not less than 150 feet nor more than 700 feet in advance of the school grounds or school crossings (see Figure 7B-2-Figure 7B-100).~~

Support:

- ^{01A} “School grounds” typically refer to school property. However, when school property frontage is lengthy, school grounds may be interpreted as the area where students frequently cross the road.

Option:

- ⁰² A School Zone (S1-1) sign may be supplemented with a SCHOOL (S4-3P) plaque (see Figure 7B-1).
- ⁰³ A School Zone (S1-1) sign may be supplemented with an ALL YEAR (S4-7P) plaque (see Figure 7B-1) if the school operates on a 12-month schedule.
- ⁰⁴ The downstream end of a designated school zone may be identified with an END SCHOOL ZONE (S5-2) sign (see ~~Figures 7B-1 and 7B-2~~ Figure 7B-100).
- ⁰⁵ If a school zone is located on a cross street in close proximity to the intersection, a School Zone (S1-1) sign with a supplemental arrow (W16-5P or W16-6P) plaque may be installed on each approach of the street or highway to warn road users making a turn onto the cross street that they will encounter a school zone soon after making the turn.

Section 7B.10 Higher Fines Zone Signs (R2-10, R2-11) and Plaques

Standard:

01 Where increased fines are imposed for traffic violations within a designated school zone, a **BEGIN HIGHER FINES ZONE (R2-10) sign** (see Figure 7B-1) or a **FINES HIGHER (R2-6P), FINES DOUBLE (R2-6aP), or \$XX FINE (R2-6bP) plaque** (see Figure 2B-3) shall be installed as a supplement to the **School Zone (S1-1) sign** to identify the beginning point of the higher fines zone (see ~~Figures 7B-2 and 7B-3~~ **Figure 7B-100**).

Option:

02 Where appropriate, one of the following plaques may be mounted below the sign that identifies the beginning point of the higher fines zone:

- A. An S4-1P plaque (see Figure 7B-1) specifying the times that the higher fines are in effect,
- B. A WHEN CHILDREN ARE PRESENT (S4-2P) plaque (see Figure 7B-1), or
- C. A WHEN FLASHING (S4-4P) plaque (see Figure 7B-1) if used in conjunction with a yellow flashing beacon.

Standard:

03 Where a **BEGIN HIGHER FINES ZONE (R2-10) sign** or a **FINES HIGHER (R2-6P) plaque** supplementing a **School Zone (S1-1) sign** is posted to notify road users of increased fines for traffic violations, an **END HIGHER FINES ZONE (R2-11) sign** (see Figure 7B-1) or an **END SCHOOL ZONE (S5-2) sign** shall be installed at the downstream end of the zone to notify road users of the termination of the increased fines zone (see ~~Figures 7B-2 and 7B-3~~ **Figure 7B-100**).

Section 7B.11 School Advance Crossing Assembly

Standard:

- 01 The **School Advance Crossing assembly** (see Figure 7B-1) shall consist of a **School (S1-1) sign** supplemented with an **AHEAD (W16-9P) plaque** or an **XX FEET (W16-2P or W16-2aP) plaque**.
- 02 Except as provided in Paragraph 3, a **School Advance Crossing assembly** shall be used in advance (see Table 2C-4 for advance placement guidelines) of the first **School Crossing assembly** (see Section 7B.12) that is encountered in each direction as traffic approaches a school crosswalk (see ~~Figure 7B-4~~ **Figure 7B-100**).

Section 7B.12 School Crossing Assembly

Standard:

- 01 If used, the **School Crossing assembly** (see Figure 7B-1) shall be installed at the school crossing (see ~~Figures 7B-4 and 7B-5~~ **Figure 7B-100**), or as close to it as possible, and shall consist of a **School (S1-1) sign** supplemented with a **diagonal downward pointing arrow (W16-7P) plaque** to show the location of the crossing.
- 02 The **School Crossing assembly** shall not be used at crossings other than those adjacent to schools and those on established school pedestrian routes.
- 03 The **School Crossing assembly** shall not be installed on approaches controlled by a **STOP** or **YIELD** sign.

Section 7B.13 School Bus Stop Ahead Sign (S3-1)

Guidance:

- 01 The **School Bus Stop Ahead (S3-1 or S3-100) sign** (see Figure 7B-1) should be installed in advance of locations where the top flashing lights of a school bus, when stopped to pick up or discharge passengers, is not visible to road users for ~~an adequate distance~~ a distance of 700 feet in advance, and where there is no opportunity to relocate the school bus stop to provide ~~adequate sight distance~~ 700 feet of visibility.
- 01A The **School Bus Stop Ahead sign** should be located at a location where the top flashing lights of a school bus are just visible, assuming a 3.5 foot driver eye height and 8.5 foot height to the top flashing lights of the school bus, but no more than 700 feet from the school bus stop.

Option:

^{01B} A word legend for the School Bus Stop Ahead sign may be used (See S3-100 of the ASDS).

Section 7B.15 School Speed Limit Assembly (S4-1P, S4-2P, S4-3P, S4-4P, S4-6P, S5-1) and END SCHOOL SPEED LIMIT Sign (S5-3)

Guidance:

~~⁰⁷ The beginning point of a reduced school speed limit zone should be at least 200 feet in advance of the school grounds, a school crossing, or other school related activities; however, this 200-foot distance should be increased if the reduced school speed limit is 30 mph or higher.~~

^{07A} The reduced speed school zone should begin at a point approximately 300 feet from the school crosswalk, if there is one. If a marked crosswalk is not present, the reduced speed school zone should begin at a point at approximately 100 feet in advance of the school area.

^{07B} The School Speed Limit (S5-1) sign should be supplemented by a Speed Limit Beacon consisting of three signal sections with a flashing CIRCULAR YELLOW signal indication of 8-inch diameter in each signal section. The signal sections should be mounted vertically directly above the S5-1 sign. The bottom two beacons should be illuminated alternatively and face oncoming traffic. The top flashing beacon should face the opposite direction to indicate when the beacon is in operation.

Figure 7B-100. School Zone Traffic Control

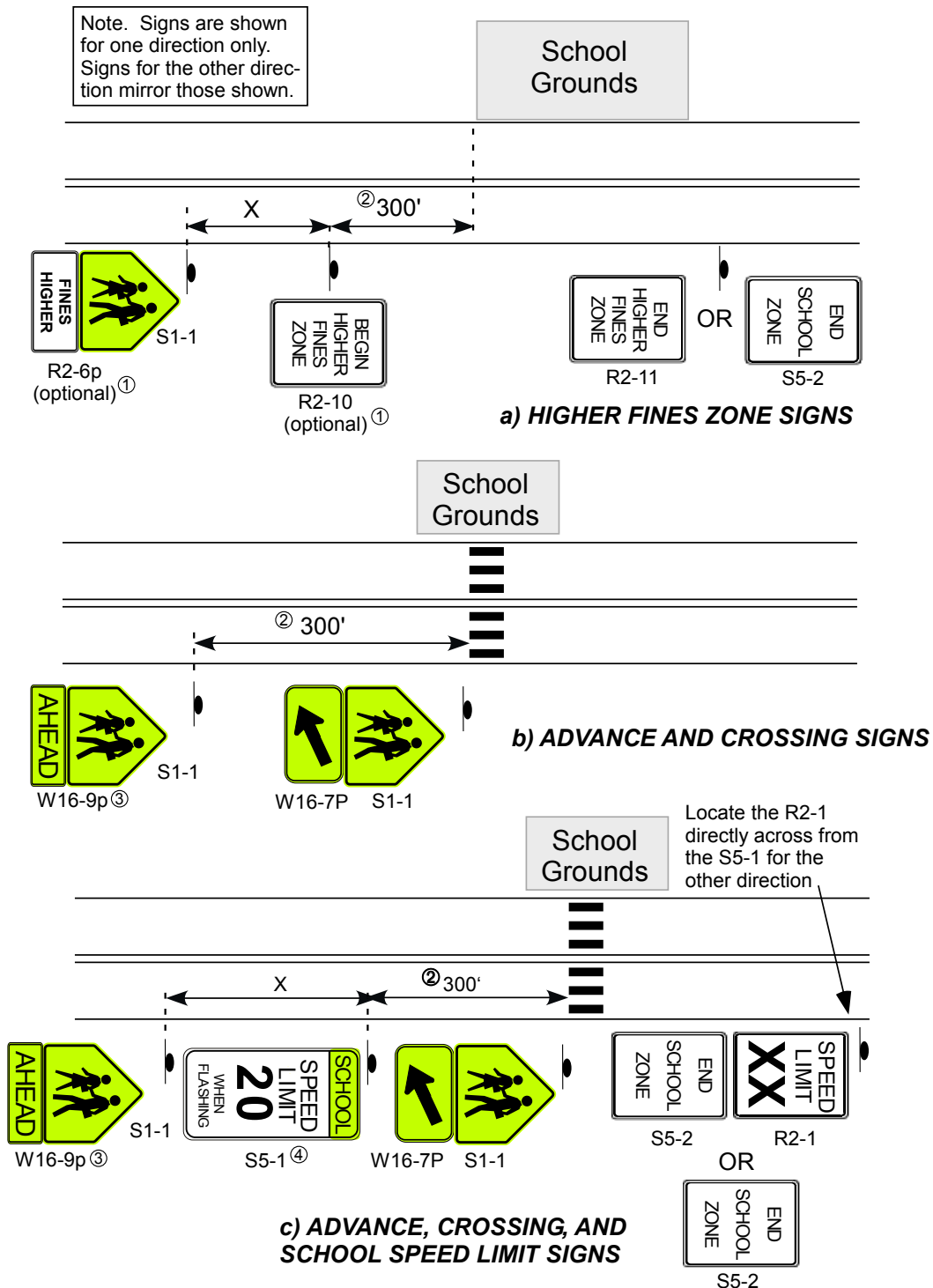

① Use either R2-6p or R2-10

② 300' (see 13 AAC 02.325) from crosswalk, if there is one, or 100' from school grounds or frequently-used crossing areas (see 7B.11)

X: Advance warning distance in feet (See MUTCD Table 2C-4 - Use Condition B)

③ W16-9p signs may be replaced with W16-2 "XX FT" or W16-2a "XX FEET" signs.

④ Options to the S5-1: School Speed Limit Assemblies with Time of Day (S4-1p), WHEN CHILDREN ARE PRESENT (S4-2p), or Day of Week (S4-6p) plates.

Section 7B.16 Reduced School Speed Limit Ahead Sign (S4-5, S4-5a)

Guidance:

- ⁰¹ *A Reduced School Speed Limit Ahead (S4-5, S4-5a) sign (see Figure 7B-1) should be used to inform road users of a reduced speed zone where the speed limit is being reduced by ~~more than 10 mph~~ 20 mph or more, or where engineering judgment indicates that advance notice would be appropriate.*

Section 7B.100 DRUG FREE SCHOOL ZONE Sign (S6-100)

[This is a new section. There is no corresponding section in the MUTCD.]

Standard:

- ⁰¹ **Alaska Statute 28.01.010(d) states, “The municipality shall post a sign indicating that the school is a drug-free school zone at each location in which it has installed a sign identifying the location of a school.” Accordingly, signs conveying this message shall be placed below, or near, all School Advance Warning (S1-1) signs.**

Support:

- ⁰² The posting of this sign is a municipal, not a state, responsibility.

Option:

- ⁰³ The sign may be the S6-100 shown in the ASDS or another sign that conveys the required message.

CHAPTER 7C. MARKINGS

Section 7C.02 Crosswalk Markings

Guidance:

- 01 *Crosswalks should be marked at all intersections on established routes to a school where there is substantial conflict between motorists, bicyclists, and student movements; where students are encouraged to cross between intersections; where students would not otherwise recognize the proper place to cross; or where motorists or bicyclists might not expect students to cross (see Figure 7A-1).*
- 02 *Crosswalk lines should not be used indiscriminately. An engineering study considering the factors described in Section 3B.18 should be performed before a marked crosswalk is installed at a location away from a traffic control signal or an approach controlled by a STOP or YIELD sign.*
- 03 *Because non-intersection school crossings are generally unexpected by the road user, warning signs (see Sections 7B.11 and 7B.12) should be installed for all marked school crosswalks at non-intersection locations. Adequate visibility of students by approaching motorists and of approaching motorists by students should be provided by parking prohibitions or other appropriate measures.*

Support:

- 04 Section 3B.18 contains provisions regarding the placement and design of crosswalks, and Section 3B.16 contains provisions regarding the placement and design of the stop lines and yield lines that are associated with them. Provisions regarding the curb markings that can be used to establish parking regulations on the approaches to crosswalks are contained in Section 3B.23.

Standard:

- 04A **Crosswalk markings shall be placed at officially designated school crossings.**
- 04B **School crosswalks shall be installed in accordance with the applicable provisions of Section 3B.18.**

CHAPTER 7D. CROSSING SUPERVISION

Section 7D.01 Types of Crossing Supervision

Support:

- 01 There are three types of school crossing supervision:
 - A. Adult control of pedestrians and vehicles by adult crossing guards,
 - B. Adult control of pedestrians and vehicles by uniformed law enforcement officers, and
 - C. Student and/or parent control of only pedestrians with student and/or parent patrols.
- 02 Information regarding the organization, administration, and operation of a school safety patrol program is contained in the “AAA School Safety Patrol Operations Manual” (see Section 1A.11).

Standard:

- 03 **School districts shall be responsible for deciding where to provide appropriate crossing supervision, for compensating them, and for ensuring appropriate high-visibility apparel is worn.**

(This page left intentionally blank.)

PART 8

TRAFFIC CONTROL FOR RAILROAD AND LIGHT RAIL TRANSIT GRADE CROSSINGS

CHAPTER 8A. GENERAL

Section 8A.02 Use of Standard Devices, Systems, and Practices at Highway-Rail Grade Crossings

Guidance:

~~02—The appropriate traffic control system to be used at a highway-rail grade crossing should be determined by an engineering study involving both the highway agency and the railroad company.~~

02A Before any improvement is made at a railroad-highway crossing, an engineering study involving both the highway authority and the railroad company should be conducted to determine what actions should be taken to enhance safety at the crossing. Actions may include the installation of traffic control systems or other improvements that have a demonstrated capacity to enhance safety and operations at the crossing.

02B With regard to traffic control systems, the following should apply:

- A. As a minimum, crossbucks, advance warning signs, appropriate regulatory signs, and pavement markings as prescribed in Part 8 of the MUTCD should be installed.
- B. The determination of the type of highway traffic control system, other than the minimum as required in A above, at a particular crossing is a two-step process.
 1. The first step is to calculate an Accident Prevention Value (APV) or hazard index of the crossing in question. The APV should be expressed in accidents per year.
The APV should be calculated using the procedures from the Rail-Highway Crossing Resource Allocation Procedure-User's Guide, Second Edition (FHWA-IP-86-11), available through the National Technical Information Service.
Using the calculated APV and the existing type of highway traffic control system at the crossing, the calculated APV should be compared to threshold values in Table 8A-100 to determine the type of traffic control system that should be installed.
 2. The second step is to have the crossing evaluated by a diagnostic team as required by the Alaska Policy on Railroad/Highway Crossings.
- C. When a diagnostic team recommends the installation of a traffic control system different from that indicated by APV threshold values, or recommends another type of crossing improvement, the recommendation of the diagnostic team should take precedence over the quantitative procedure.

Table 8A-100. Qualitative Procedure

Existing Traffic Control Device	Calculated Accident Prediction Value, APV	Recommended Action for Improvement
Passive	0.08 to 0.12*	See note below.
	0.12 to 0.15	Flashing lights
	0.15 to 0.23	Flashing lights or gates and flashing lights
	0.23 to 12.4	Gates and flashing lights
	12.4 to 18.5	Gates and flashing lights or grade separation
Flashing lights	Greater than 18.5	Grade separation
	0.12 to 0.18*	See note below
	0.18 to 3.7	Gates and flashing lights
Gates	3.7 to 5.6	Gates and flashing lights or grade separation
	Greater than 5.6	Grade separation
Gates	1.32 to 1.98*	See note below
	Greater than 1.98	Grade separation

* When the calculated hazard index falls within this range, the decision may be to do nothing, improve the existing traffic control system, install a different type of traffic control system, or make some other improvement at the crossing.

Option:

03 The engineering study may include the Highway-Rail Intersection (HRI) components of the National Intelligent Transportation Systems (ITS) architecture, which is a USDOT accepted method for linking the highway, vehicles, and traffic management systems with rail operations and wayside equipment.

03A Consistent with the Alaska Policy on Railroad/Highway Crossings, other improvements that may be considered for enhancing crossing safety include:

- A. Improving sight distance to increase the visibility of the crossing and the train
- B. Closing the crossing
- C. Improving the approach alignment and/or grade of the roadway
- D. Instituting and enforcing railroad and/or highway operating regulations
- E. Improving the crossing surface
- F. Illuminating the crossing

Support:

04 More detail on Highway-Rail Intersection components is available from the USDOT’s Federal Railroad Administration, 1200 New Jersey Avenue, SE, Washington, DC 20590, or www.fra.dot.gov.

Standard:

05 **Traffic control devices, systems, and practices shall be consistent with the design and application of the Standards contained in this Manual.**

06 **Before any new highway-rail grade crossing traffic control system is installed or before modifications are made to an existing system, approval shall be obtained from the highway agency with the jurisdictional and/or statutory authority, and from the railroad company. the Alaska Policy on Railroad/ Highway Crossings shall be implemented.**

CHAPTER 8B. SIGNS AND MARKINGS

[Revise Table 8B-1 of the 2009 MUTCD as shown in this ATMS. The remainder of Table 8B-1 remains as shown in the 2009 MUTCD.]

Table 8B-1. Grade Crossing Sign and Plaque Minimum Sizes

Sign or Plaque	Sign Designation	Section	Conventional Road		Expressway	Minimum	Oversized
			Single Lane	Multi-Lane			
Stop	R1-1	8B.04, 8B.05	30 x 30	36 x 36	36 x 36	—	48 x 48
Yield	R1-2	8B.04, 8B.05	36 x 36 x 36	48 x 48 x 48 36 x 36 x 36	48 x 48 x 48	30 x 30 x 30	—

Section 8B.03 Grade Crossing (Crossbuck) Sign (R15-1) and Number of Tracks Plaque (R15-2P) at Active and Passive Grade Crossings

Standard:

- 05 If automatic gates are not present and if there are two or more tracks at a grade crossing, the number of tracks shall be indicated on a supplemental Number of Tracks (R15-2P) plaque (see Figure 8B-1) of inverted T shape mounted below the Crossbuck sign in the manner shown in Figure 8B-2.
- 06 On each approach to a highway-rail grade crossing and, if used, on each approach to a highway-LRT grade crossing, the Crossbuck sign shall be installed on the right-hand side of the highway on each approach to the grade crossing. Where restricted sight distance or unfavorable highway geometry exists on an approach to a grade crossing, an additional Crossbuck sign shall be installed on the left-hand side of the highway, possibly placed back-to-back with the Crossbuck sign for the opposite approach, or otherwise located so that two Crossbuck signs are displayed for that approach.
- 07 A strip of high-intensity or brighter retroreflective white material not less than \geq 6 inches in width shall be ~~used~~ mounted on the back of each blade of each Crossbuck sign for the length of each blade, at all grade crossings where Crossbuck signs have been installed, except those where Crossbuck signs have been installed back-to-back.

Section 8B.04 Crossbuck Assemblies with YIELD or STOP Signs at Passive Grade Crossings

Standard:

- 15 A vertical strip of high-intensity or brighter retroreflective white material, not less than 2 inches in width, shall be ~~used~~ mounted on each Crossbuck support at passive grade crossings for the full length of the back of the support from the Crossbuck sign or Number of Tracks plaque to within 2 feet above the ground, except as provided in Paragraph 16.

Option:

- 16 The vertical strip of high-intensity or brighter retroreflective material may be omitted from the back sides of Crossbuck sign supports installed on one-way streets.
- 17 If a YIELD or STOP sign is installed on the same support as the Crossbuck sign, a vertical strip of red (see Section 2A.21) or white high-intensity or brighter retroreflective material that is at least 2 inches wide may be used on the front of the support from the YIELD or STOP sign to within 2 feet above the ground.

Section 8B.06 Grade Crossing Advance Warning Signs (W10 Series)

Standard:

- ⁰¹ A Highway-Rail Grade Crossing Advance Warning (W10-1) sign (see Figure 8B-4) shall be used on each highway in advance of every highway-rail grade crossing, and every highway-LRT grade crossing in semi-exclusive alignments, except in the following circumstances:
- A. On an approach to a grade crossing from a T-intersection with a parallel highway if the distance from the edge of the track to the edge of the parallel roadway is less than 100 feet and W10-3 signs are used on both approaches of the parallel highway;
 - B. On low-volume, low-speed highways crossing minor spurs or other tracks that are infrequently used and road users are directed by an authorized person on the ground to not enter the crossing at all times that approaching rail traffic is about to occupy the crossing;
 - C. In business or commercial areas where active grade crossing traffic control devices are in use; or
 - D. Where physical conditions do not permit even a partially effective display of the sign.
- ⁰² The placement of the Grade Crossing Advance Warning sign shall be in accordance with Section 2C.05 and Table 2C-4.
- ⁰³ A Yield Ahead (W3-2) or Stop Ahead (W3-1) Advance Warning sign (see Figure 2C-6) shall also be installed if the criteria for their installation given in Section 2C.36 are met. If a Yield Ahead or Stop Ahead sign is installed on the approach to the crossing, the W10-1 sign shall be installed upstream from the Yield Ahead or Stop Ahead sign. The Yield Ahead or Stop Ahead sign shall be located in accordance with Table 2C-4. The minimum distance between the signs shall be in accordance with Section 2C.05 and Table 2C-4.

Option:

- ~~⁰⁴ On divided highways and one-way streets, an additional W10-1 sign may be installed on the left-hand side of the roadway.~~

Guidance:

- ^{04A} *On divided highways and one-way streets, an additional W10-1 sign should also be installed on the left-hand side of the roadway.*

Section 8B.09 DO NOT STOP ON TRACKS Sign (R8-8)

Guidance:

- ⁰¹ A DO NOT STOP ON TRACKS (R8-8) sign (see Figure 8B-1) should be installed whenever an engineering study determines that the potential for highway vehicles stopping on the tracks at a grade crossing is significant. Placement of the R8-8 sign should be determined as part of the engineering study. The sign, if used, should be located on the right-hand side of the highway on either the near or far side of the grade crossing, depending upon which position provides better visibility to approaching drivers.
- ⁰² If a STOP or YIELD sign is installed at a location, including at a circular intersection, that is downstream from the grade crossing such that highway vehicle queues are likely to extend beyond the tracks, a DO NOT STOP ON TRACKS sign (R8-8) should be used.
- ^{02A} *On divided highways and one-way streets, a second DO NOT STOP ON TRACKS sign should be placed on the near or far left-hand side of the highway-rail grade crossing to further improve visibility of the sign.*

Option:

- ⁰³ DO NOT STOP ON TRACKS signs may be placed on both sides of the track.
- ~~⁰⁴ On divided highways and one-way streets, a second DO NOT STOP ON TRACKS sign may be placed on the near or far left-hand side of the highway at the grade crossing to further improve visibility of the sign.~~

Section 8B.27 Pavement Markings

Standard:

- ⁰¹ All grade crossing pavement markings shall be retroreflectorized white. All other markings shall be in accordance with Part 3.

02 On paved roadways, pavement markings in advance of a grade crossing shall consist of an X, the letters RR, a no-passing zone marking (on two-lane, two-way highways with center line markings in compliance with Section 3B.01), and certain transverse lines as shown in Figures 8B-6 and 8B-7.

03 Identical markings shall be placed in each approach lane on all paved approaches to grade crossings where signals or automatic gates are located, and at all other grade crossings where the posted or statutory highway speed is 40 mph or greater, and on all multilane roads.

~~04 Pavement markings shall not be required at grade crossings where the posted or statutory highway speed is less than 40 mph if an engineering study indicates that other installed devices provide suitable warning and control. Pavement markings shall not be required at grade crossings in urban areas if an engineering study indicates that other installed devices provide suitable warning and control.~~

Guidance:

05 *Identical pavement markings should be placed in each approach lane on all paved approaches to highway-rail grade crossings. When pavement markings are used, a portion of the X symbol should be directly opposite the Grade Crossing Advance Warning sign. The X symbol and letters should be elongated to allow for the low angle at which they will be viewed.*

Option:

06 When justified by engineering judgment, supplemental pavement marking symbol(s) may be placed between the Grade Crossing Advance Warning sign and the grade crossing.

Section 8B.100 BICYCLES (skewed track crossing symbol) USE CAUTION (W10-100)

[This is a new section. There is no corresponding section in the MUTCD.]

Standard:

01 **The BICYCLES (skewed track crossing symbol) USE CAUTION (W10-100) sign shall be used on all paved roadways and paths in advance of railroad grade crossings that are skewed 15 degrees or more.**

Guidance:

02 *If used, the sign should be placed 65 feet in advance of the near rail of the skewed railroad crossing.*

CHAPTER 8C. FLASHING-LIGHT SIGNALS, GATES, AND TRAFFIC CONTROL SIGNALS

Section 8C.02 Flashing-Light Signals

Standard:

- 04 When indicating the approach or presence of rail traffic, the flashing-light signal shall display toward approaching highway traffic two red lights mounted in a horizontal line flashing alternately.
- 05 If used, flashing-light signals shall be placed to the right of approaching highway traffic on all highway approaches to a grade crossing. They shall be located laterally with respect to the highway in compliance with Figure 8C-1 except where such location would adversely affect signal visibility.
- 06 If used at a grade crossing with highway traffic in both directions, back-to-back pairs of lights shall be placed on each side of the tracks. On multi-lane one-way streets and divided highways, flashing-light signals shall be placed on the approach side of the grade crossing on both sides of the roadway or shall be placed above the highway.
- 07 Each red signal unit in the flashing-light signal shall flash alternately. The number of flashes per minute for each lamp shall be 35 minimum and 65 maximum. Each lamp shall be illuminated approximately the same length of time. Total time of illumination of each pair of lamps shall be the entire operating time. Flashing-light units shall use ~~either 8-inch or~~ 12-inch nominal diameter lenses.

Guidance:

- ~~00 In choosing between the 8-inch or 12-inch nominal diameter lenses for use in grade crossing flashing-light signals, consideration should be given to the principles stated in Section 4D.07.~~

Figure 8C-1. Composite Drawing of Active Traffic Control Devices for Grade Crossings Showing Clearances

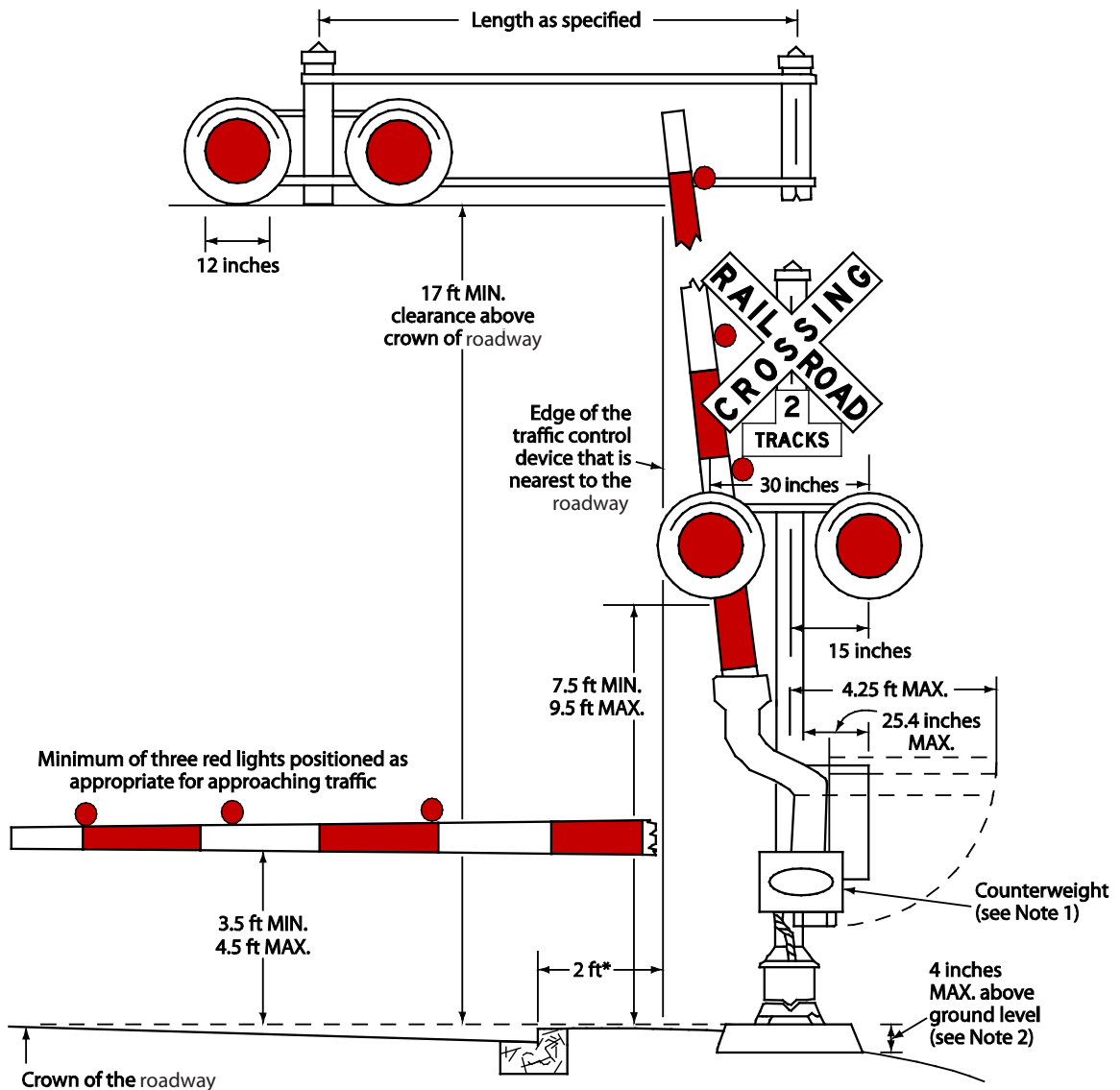

*For locating this reference line on an approach that does not have a curb, see Section 8C.01.

Notes:

1. Where gates are located in the median, additional median width may be required to provide the minimum clearance for the counterweight supports.
2. The top of the signal foundation should be no more than 4 inches above the surface of the ground and should be at the same elevation as the crown of the roadway. Where site conditions would not allow this to be achieved, the shoulder side slope should be re-graded or the height of the signal post should be adjusted to meet the 17-foot vertical clearance requirement.

(This page left intentionally blank.)

PART 9

TRAFFIC CONTROL FOR BICYCLE FACILITIES

CHAPTER 9B. SIGNS

Section 9B.18 Bicycle Warning and Combined Bicycle/Pedestrian Signs (W11-1 and W11-15)

[Modify the first sentence of the note in Figure 9B-3 to read: “A fluorescent yellow-green background color may be used for this sign or plaque only within designated school zones.”]

Standard:

⁰⁵ **Bicycle Warning and combined Bicycle/Pedestrian signs, when used at the location of the crossing, shall be supplemented with a diagonal downward pointing arrow (W16-7P) plaque (see Figure 9B-3) to show the location of the crossing.**

Option:

⁰⁶ A fluorescent yellow-green background color with a black legend and border may be used for Bicycle Warning and combined Bicycle/Pedestrian signs and supplemental plaques only within designated school zones.

Guidance:

~~⁰⁷ When the fluorescent yellow-green background color is used, a systematic approach featuring one background color within a zone or area should be used. The mixing of standard yellow and fluorescent yellow-green backgrounds within a zone or area should be avoided.~~

Support:

^{07A} The mixing of standard yellow and fluorescent yellow-green backgrounds within a school zone can confuse motorists on school zone limits. Where non-school crossings occur within a school zone, a systematic approach using fluorescent yellow-green signs can better indicate to motorists that they are still within the bounds of a school zone.

(This page left intentionally blank.)